

# DIAMOND AIRCRAFT INDUSTRIES

---

## FLIGHT MANUAL

# *DA 20-C1*

---

Category of Airworthiness	: UTILITY
Applicable Airworthiness Requirements	: AWM Chapter 523-VLA
Serial No.	:
Registration	:
Date of Issue	: 19 December 1997
Document No.	: DA202-C1

This manual must be carried in the aircraft at all times! Scope and revision status can be found in the List of Effective Pages and in the Record of Revisions.

The pages identified as "DOT-appr." in the List of Effective Pages are approved by:

Signature

  
for, Chief, Flight Test  
for, Director, Aircraft Certification

Authority

Transport Canada

---

Date of approval

19 December 1997

---

This airplane is to be operated in compliance with the information and limitations contained herein.

---

## PREFACE

Congratulations on your choice of the DA 20-C1.

Safe handling of an airplane increases and ensures your safety and provides you with many hours of enjoyment. For this reason you should take the time to familiarize yourself with your new airplane.

We ask that you carefully read this Flight Manual and pay special attention to the recommendations given. A careful study of the manual will reward you with many hours of trouble-free flight operation of your airplane.

All rights reserved. Reproduction of this manual or any portion thereof by any means without the express written permission of DIAMOND AIRCRAFT INDUSTRIES prohibited.

Copyright © by DIAMOND AIRCRAFT INDUSTRIES,  
London, Ontario

---

## TABLE OF CONTENTS

	Chapter
<b>GENERAL</b>	<b>1</b>
<b>OPERATING LIMITATIONS</b>	<b>2</b>
<b>EMERGENCY PROCEDURES</b>	<b>3</b>
<b>NORMAL OPERATING PROCEDURES</b>	<b>4</b>
<b>PERFORMANCE</b>	<b>5</b>
<b>WEIGHT AND BALANCE / EQUIPMENT LIST</b>	<b>6</b>
<b>DESCRIPTION OF THE AIRPLANE AND ITS SYSTEMS</b>	<b>7</b>
<b>HANDLING, PREVENTIVE AND CORRECTIVE MAINTENANCE</b>	<b>8</b>
<b>SUPPLEMENTS</b>	<b>9</b>



**LIST OF EFFECTIVE PAGES**

Chapter	Page	Date	Chapter	Page	Date
0	0-1	October 18, 2002	3	DOT-appr 3-1	December 19, 1997
	0-2	October 18, 2002		DOT-appr 3-2	March 10, 1999
	0-3	December 19, 1997		DOT-appr 3-3	June 21, 1999
	0-4	December 11, 2007		DOT-appr 3-4	June 21, 1999
	0-5	November 2, 2007		DOT-appr 3-5	April 23, 2002
	0-6	December 11, 2007		DOT-appr 3-6	April 23, 2002
	0-7	August 9, 2001		DOT-appr 3-7	March 10, 1999
	0-8	August 9, 2001		DOT-appr 3-8	June 21, 1999
	0-9	August 18, 2005		DOT-appr 3-9	June 21, 1999
	0-10	December 11, 2007		DOT-appr 3-10	December 19, 1997
	0-11	December 11, 2007		DOT-appr 3-11	December 19, 1997
	0-12	September 5, 2006		DOT-appr 3-12	December 19, 1997
1	1-1	December 19, 1997	DOT-appr 3-13	December 19, 1997	
	1-2	August 28, 1998	DOT-appr 3-14	December 19, 1997	
	1-3	August 9, 2001	DOT-appr 3-15	December 08, 1998	
	1-4	March 10, 1999	DOT-appr 3-16	December 19, 1997	
	1-5	August 9, 2001	DOT-appr 3-17	December 19, 1997	
	1-6	December 19, 1997	DOT-appr 3-18	December 19, 1997	
	1-7	December 19, 1997	4	DOT-appr 4-1	April 23, 2002
	1-8	April 23, 2002		DOT-appr 4-2	April 23, 2002
	1-9	December 19, 1997		DOT-appr 4-3	December 7, 1999
	1-10	December 19, 1997		DOT-appr 4-4	December 19, 1997
	1-11	December 19, 1997		DOT-appr 4-5	October 18, 2002
1-12	December 19, 1997	DOT-appr 4-6		December 7, 1999	
1-13	April 23, 2002	DOT-appr 4-7		December 7, 1999	
2	DOT-appr 2-1	December 11, 2007		DOT-appr 4-8	March 10, 1999
	DOT-appr 2-2	April 23, 2002		DOT-appr 4-9	December 19, 1997
	DOT-appr 2-3	December 7, 1999		DOT-appr 4-10	December 7, 1999
	DOT-appr 2-4	December 11, 2007		DOT-appr 4-11	December 7, 1999
	DOT-appr 2-5	June 24, 2005	DOT-appr 4-12	December 7, 1999	
	DOT-appr 2-6	April 23, 2002	DOT-appr 4-13	December 7, 1999	
	DOT-appr 2-7	December 11, 2007	DOT-appr 4-14	December 11, 2007	
	DOT-appr 2-8	December 11, 2007	DOT-appr 4-15	April 23, 2002	
	DOT-appr 2-9	December 11, 2007	DOT-appr 4-16	March 19, 2004	
	DOT-appr 2-10	December 11, 2007	DOT-appr 4-17	December 7, 1999	
	DOT-appr 2-11	December 11, 2007	DOT-appr 4-18	August 9, 2001	
	DOT-appr 2-12	December 11, 2007	DOT-appr 4-19	April 23, 2002	
	DOT-appr 2-13	December 11, 2007	DOT-appr 4-20	December 11, 2007	
	DOT-appr 2-14	December 11, 2007			
	DOT-appr 2-15	December 11, 2007			
	DOT-appr 2-16	December 11, 2007			
	DOT-appr 2-17	December 11, 2007			
	DOT-appr 2-18	December 11, 2007			
	DOT-appr 2-19	December 11, 2007			



Chapter	Page	Date	Chapter	Page	Date	
5	5-1	August 28, 1998		7-13	March 19, 2004	
	5-2	August 28, 1998		7-14	December 08, 1998	
	DOT-appr 5-3	April 23, 2002		7-15	24 June, 2005	
	5-4	March 20, 2001		7-16	24 June, 2005	
	5-5	August 9, 2001		7-17	December 7, 1999	
	DOT-appr 5-6	August 28, 1998		7-18	October 18, 2002	
	DOT-appr 5-7	August 14, 2000		7-19	December 7, 1999	
	DOT-appr 5-8	August 28, 1998		7-20	December 7, 1999	
	DOT-appr 5-9	August 9, 2001		7-21	October 18, 2002	
	DOT-appr 5-10	August 28, 1998		7-22	December 7, 1999	
	DOT-appr 5-11	August 9, 2001		8	8-1	August 9, 2001
	DOT-appr 5-12	August 28, 1998			8-2	December 19, 1997
	DOT-appr 5-13	August 9, 2001			8-3	October 18, 2002
	5-14	August 28, 1998			8-4	October 18, 2002
	5-15	August 9, 2001			8-5	December 19, 1997
	5-16	August 28, 1998			8-6	October 18, 2002
	5-17	August 9, 2001			8-7	December 19, 1997
	DOT-appr 5-18	August 28, 1998		9	DOT-appr 9-1	December 19, 1997
	DOT-appr 5-19	August 9, 2001			DOT-appr 9-2	October 18, 2002
	DOT-appr 5-20	November 2, 2007				
6	6-1	April 23, 2002				
	DOT-appr 6-2	March 10, 1999				
	DOT-appr 6-3	March 20, 2001				
	DOT-appr 6-4	December 19, 1997				
	DOT-appr 6-5	March 20, 2001				
	DOT-appr 6-6	March 10, 1999				
	6-7	October 18, 2002				
	DOT-appr 6-8	April 23, 2002				
	DOT-appr 6-9	April 23, 2002				
	DOT-appr 6-10	April 23, 2002				
	DOT-appr 6-11	April 23, 2002				
	DOT-appr 6-12	May 28, 2001				
	6-13	March 22, 2005				
	6-14	March 22, 2005				
	6-15	September 5, 2006				
	6-16	September 5, 2006				
7	7-1	December 7, 1999				
	7-2	December 19, 1997				
	7-3	March 10, 1999				
	7-4	December 19, 1997				
	7-5	December 19, 1997				
	7-6	September 5, 2006				
	7-7	December 08, 1998				
	7-8	March 10, 1999				
	7-9	December 19, 1997				
	7-10	December 19, 1997				
	7-11	December 7, 1999				
	7-12	March 19, 2004				



**SUPPLEMENTS LIST OF EFFECTIVE PAGES**

**NOTE**

It is only necessary to maintain those supplements which pertain to optional equipment that may be installed in your airplane.

Refer to Page 9-2 for index of supplements.

Supp	Page	Date	Supp	Page	Date
S1	DOT-appr S1-1	May 28, 2001		DOT-appr S5-9	December 7, 1999
	DOT-appr S1-2	May 28, 2001		DOT-appr S5-10	December 7, 1999
	DOT-appr S1-3	May 28, 2001	S6	DOT-appr S6-1	December 7, 1999
	DOT-appr S1-4	May 28, 2001		DOT-appr S6-2	December 7, 1999
	DOT-appr S1-5	May 28, 2001		DOT-appr S6-3	December 7, 1999
	DOT-appr S1-6	May 28, 2001		DOT-appr S6-4	December 7, 1999
	DOT-appr S1-7	May 28, 2001		DOT-appr S6-5	December 7, 1999
	DOT-appr S1-8	May 28, 2001		DOT-appr S6-6	December 7, 1999
	DOT-appr S1-9	May 28, 2001		DOT-appr S6-7	December 7, 1999
S2	DOT-appr S2-1	March 19, 2004	S7	DOT-appr S7-1	December 7, 1999
	DOT-appr S2-2	March 19, 2004		DOT-appr S7-2	December 7, 1999
	DOT-appr S2-3	March 19, 2004		DOT-appr S7-3	December 7, 1999
	DOT-appr S2-4	March 19, 2004		DOT-appr S7-4	December 7, 1999
S3	DOT-appr S3-1	March 10, 1999		DOT-appr S7-5	December 7, 1999
	DOT-appr S3-2	March 10, 1999	DOT-appr S7-6	December 7, 1999	
	DOT-appr S3-3	March 10, 1999	S8	DOT-appr S8-1	December 7, 1999
	DOT-appr S3-4	March 10, 1999		DOT-appr S8-2	December 7, 1999
S4	DOT-appr S4-1	December 11, 2007		DOT-appr S8-3	December 7, 1999
	DOT-appr S4-2	August 18, 2005	S9	DOT-appr S9-1	January 16, 2001
	DOT-appr S4-3	August 18, 2005		DOT-appr S9-2	January 16, 2001
	DOT-appr S4-4	December 11, 2007		DOT-appr S9-3	October 18, 2002
	DOT-appr S4-5	December 11, 2007	S10	DOT-appr S10-1	January 16, 2001
	DOT-appr S4-6	December 11, 2007		DOT-appr S10-2	January 16, 2001
	DOT-appr S4-7	December 11, 2007		DOT-appr S10-3	October 18, 2002
	DOT-appr S4-8	December 11, 2007	S11	DOT-appr S11-1	August 9, 2001
	DOT-appr S4-9	December 11, 2007		DOT-appr S11-2	August 9, 2001
	DOT-appr S4-10	December 11, 2007		DOT-appr S11-3	August 9, 2001
	DOT-appr S4-11	December 11, 2007		DOT-appr S11-4	August 9, 2001
	DOT-appr S4-12	December 11, 2007		DOT-appr S11-5	August 9, 2001
	DOT-appr S4-13	December 11, 2007			
	DOT-appr S4-14	December 11, 2007			
	DOT-appr S4-15	December 11, 2007			
	DOT-appr S4-16	December 11, 2007			
S5	DOT-appr S5-1	December 7, 1999			
	DOT-appr S5-2	December 7, 1999			
	DOT-appr S5-3	December 7, 1999			
	DOT-appr S5-4	December 7, 1999			
	DOT-appr S5-5	December 7, 1999			
	DOT-appr S5-6	December 7, 1999			
	DOT-appr S5-7	December 7, 1999			
	DOT-appr S5-8	December 7, 1999			

## RECORD OF REVISIONS

Revisions to this manual, with the exception of actual weighing data, are recorded in the following table.

Revisions of approved sections must be endorsed by the responsible airworthiness authority.

The new or amended text will be indicated by a bold black vertical line in the left hand margin of a revised page. Revision number and reference will be shown on the bottom left hand corner of the page.

The airplane may only be operated if the Flight Manual is up to date.

Rev. No	Affected Pages	Approved	
		Date	Name
Issue 1	All	December 19, 1997	W. Jupp for, Chief, Flight Test for, Director, Aircraft Certification Transport Canada
Rev 1	0-4, 0-5, 0-6, 1-5, 2-9, 2-10, 2-11, 6-9, 6-13, 6-14, 7-14	August 13, 1998	R. Walker for, Chief, Flight Test for, Director, Aircraft Certification Transport Canada
Rev 2	0-4, 0-5, 0-6, 0-8, 1-2, 1-3, 1-5, 2-4, 3-5, 3-6, 4-2, 5-1, 5-2, 5-4 to 5-20, 6-3, 6-5, 6-15, 7-12	August 28, 1998	W. Jupp for, Chief, Flight Test for, Director, Aircraft Certification Transport Canada
Rev 3	0-4, 0-5, 0-6, 3-2, 3-4, 3-5, 3-6, 3-7, 3-9, 3-15, 4-10, 4-11, 4-12, 4-13, 4-14, 4-15, 4-16, 4-17, 4-18, 6-13, 6-14, 6-15, 7-1, 7-7, 7-8, 7-12, 7-13, 7-14, 7-15, 7-16, 7-17, 7-18, 7-19, 7-20, 7-21, 9-2, S1-1, S1-2, S1-3, S1-4, S1-5, S1-6, S1-7, S1-8	December 08, 1998	R. Walker A/ Chief, Flight Test for, Director, Aircraft Certification Transport Canada
Rev 4	0-4, 0-5, 0-6, 6-14, 9-2, S2-1, S2-2, S2-3	January 5, 1999	W. Jupp Chief, Flight Test for Director, Aircraft Certification Transport Canada
Rev 5	0-4, 0-5, 0-6, 0-8, 1-3, 1-4, 2-16, 3-2, 3-3, 3-7, 4-8, 4-10, 5-13, 6-1, 6-2, 6-3, 6-5, 6-6, 6-7, 6-12, 6-13, 6-14, 6-15, 7-3, 7-16, 9-2, S3-1, S3-2, S3-3, S3-4	March 10, 1999	W. Jupp Chief, Flight Test for Director, Aircraft Certification Transport Canada
Rev 6	0-4, 0-5, 0-6, 0-7, 0-8, 0-9, 9-2, S4-1, S4-2, S4-3, S4-4, S4-5, S4-6, S4-7, S4-8, S4-9, S4-10, S4-11, S4-12, S4-13, S4-14, S4-15, S4-16, S4-17, S4-18, S4-19, S4-20	April 7, 1999	W. Jupp Chief, Flight Test for Director, Aircraft Certification Transport Canada

**RECORD OF REVISIONS (continued)**

Rev 7	0-4, 0-5, 0-8, 0-9, 0-10, 2-3, 2-5, 2-14, 3-3, 3-4, 3-5, 3-6, 3-8, 3-9, 4-10, 4-11, 4-12, 4-13, 4-14, 4-15, 4-16, 4-17, 4-18, 7-6, 7-17.	June 21, 1999	W. Jupp Chief, Flight Test for Director, Aircraft Certification Transport Canada
Rev 8	0-4, 0-5, 0-6, 0-8, 2-1, 2-3, 2-10, 2-11, 2-12, 2-13, 2-14, 2-15, 2-16, 2-17, 4-1, 4-3, 4-6, 4-7, 4-10, 4-11, 4-12, 4-13, 4-14, 4-15, 4-16, 4-17, 4-18, 4-19, 6-13, 6-14, 6-15, 7-1, 7-6, 7-11, 7-15, 7-16, 7-17, 7-18, 7-19, 7-20, 7-21, 7-22, 9-2, S5-1, S5-2, S5-3, S5-4, S5-5, S5-6, S5-7, S5-8, S5-9, S5-10, S6-1, S6-2, S6-3, S6-4, S6-5, S6-6, S6-7, S7-1, S7-2, S7-3, S7-4, S7-5, S7-6, S8-1, S8-2, S8-3.	December 7, 1999	W. Jupp Chief, Flight Test for Director, Aircraft Certification Transport Canada
Rev 9	0-4, 0-8, 2-9, 2-12, 2-15, 2-16.	April 11, 2000	W. Jupp Chief, Flight Test for Director, Aircraft Certification Transport Canada
Rev 10	0-4, 0-5, 0-8, 1-5, 2-9, 2-12, 2-17, 4-2, 5-7, 5-17	August 14, 2000	W. Jupp Chief, Flight Test for Director, Aircraft Certification Transport Canada
Rev 11	0-4, 0-5, 0-6, 0-8, 9-2, S9-1, S9-2, S9-3, S10-1, S10-2, S10-3.	January 16, 2001	W. Jupp Chief, Flight Test for Director, Aircraft Certification Transport Canada
Rev 12	0-4, 0-5, 0-6, 0-8, 1-5, 2-4, 2-10, 5-4, 5-5, 5-9, 5-11, 5-13, 5-15, 5-17, 5-19, 6-3, 6-5, S4-8.	March 20, 2001	W. Jupp Chief, Flight Test for Director, Aircraft Certification Transport Canada
Rev 13	0-4, 0-5, 0-6, 0-7, 0-8, 6-12, 6-13, 6-14, 6-15, 6-16, 9-2, S1-1, S1-2, S1-3, S1-4, S1-5, S1-6, S1-7, S1-8, S1-9.	May 28, 2001	W. Jupp Chief, Flight Test for Director, Aircraft Certification Transport Canada

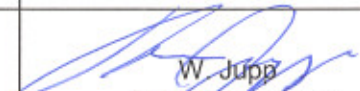

**RECORD OF REVISIONS (continued)**

Rev 14	0-4, 0-5, 0-6, 0-7, 0-8, 0-9, 0-10, 0-11, 1-3, 1-5, 2-4, 2-5, 2-10, 2-15, 4-1, 4-18, 5-5, 5-9, 5-11, 5-13, 5-15, 5-17, 5-19, 6-16, 8-1, 8-3, 9-2, S4-1, S4-2, S4-3, S4-4, S4-5, S4-6, S4-7, S4-8, S4-9, S4-10, S4-11, S4-12, S4-13, S4-14, S4-15, S4-16, S4-17, S4-18, S4-19, S4-20, S11-1, S11-2, S11-3, S11-4, S11-5.	August 9, 2001	W. Jupp Chief, Flight Test for Director, Aircraft Certification Transport Canada
Rev 15	0-4, 0-5, 0-6, 0-9, 1-8, 1-13, 2-2, 2-6, 2-7, 2-13, 2-14, 2-17, 2-18, , 3-5, 3-6, 4-1, 4-2, 4-15, 4-19, 4-20, 5-3, 6-1, 6-8, 6-9, 6-10, 6-11, 6-15, 9-2, S4-2, S4-5, S4-19.	April 23, 2002	K.W. Horton A/ Chief, Flight Test for Director, Aircraft Certification Transport Canada
Rev 16	0-1, 0-2, 0-4, 0-5, 0-6, 0-9, 0-11, 2-1, 4-5, 6-7, 6-13, 6-14, 6-15, 6-16, 7-6, 7-18, 7-21, 8-3, 8-4, 8-6, 9-2, S4-1, S4-2, S4-3, S4-4, S4-5, S4-6, S4-7, S4-8, S4-9, S4-10, S4-11, S4-12, S4-13, S4-14, S4-15, S9-3, S10-3.	October 18, 2002	W. Jupp Chief, Flight Test for Director, Aircraft Certification Transport Canada
Rev 17	0-4, 0-5, 0-6, 0-9, 2-7, 2-17, 4-16, 7-12, 7-13, S2-1, S2-2, S2-3, S2-4, S4-4	March 19, 2004	W. Jupp Chief, Flight Test for Director, Aircraft Certification Transport Canada
Rev 18	0-4, 0-5, 0-9 6-13, 6-14, 6-15, 6-16	March 22, 2005	W. Jupp Chief, Flight Test for Director, Aircraft Certification Transport Canada
Rev 19	0-4, 0-5, 0-9 2-5, 7-15, 7-16	June 24, 2005	W. Jupp Chief, Flight Test for Director, Aircraft Certification Transport Canada
Rev 20	0-4, 0-6, 0-9, S4-1, S4-2, S4-3, S4-4, S4-5, S4-6, S4-7, S4-8, S4-9, S4-10, S4-11, S4-12, S4-13, S4-14, S4-15		 W. Jupp Chief, Flight Test for Director, Aircraft Certification Transport Canada <i>18 August 2005</i>



Rev 21	0-4, 0-5, 0-10 , 0-11, 0-12, 6-15, 6-16, 7-6	September 5, 2006	W. Jupp Chief, Flight Test for Director, Aircraft Certification Transport Canada
TR-1	0-10, 2-5	October 2, 2007	W. Jupp Chief, Flight Test For Director, Aircraft Certification Transport Canada
Rev 22	0-4, 0-5, 0-6, 0-10, 2-4, 2-7, 2-17, 4-14, 4-20, 5-20, S4-4, S4-12, S4-13	November 2, 2007	W. Jupp Chief, Flight Test for Director, Aircraft Certification Transport Canada
Rev 23	0-4, 0-6, 0-10, 0-11, 2-1, 2-4, 2-7, 2-8, 2-9, 2-10, 2-11, 2-12, 2-13, 2-14, 2-15, 2-16, 2-17, 2-18, 2-19, 4-14, 4-20, S4-1, S4-4, S4-5, S4-6, S4-7, S4-8, S4-9, S4-10, S4-11, S4-12, S4-13, S4-14, S4-15, S4-16	December 11, 2007	 Chief, Flight Test for Director, Aircraft Certification Transport Canada

## REVISION LOG

This log should be used to record all revisions issued and inserted in this manual. The affected pages of any revision must be inserted into the manual as well as the Record of Revisions upon receipt. The pages superseded by the revision must be removed and destroyed. The Revision Log should be updated by hand. Changes are identified on those pages affected by a revision bar.

<b>Rev. No.</b>	<b>Date Issued:</b>	<b>Inserted On:</b>	<b>Inserted By:</b>
<b>Issue 1</b>	December 19, 1997	December 19, 1997	Diamond Aircraft
<b>Revision 1</b>	August 13, 1998	August 13, 1998	Diamond Aircraft
<b>Revision 2</b>	August 28, 1998	August 28, 1998	Diamond Aircraft
<b>Revision 3</b>	December 8, 1998	December 8, 1998	Diamond Aircraft
<b>Revision 4</b>	January 5, 1999	January 5, 1999	Diamond Aircraft
<b>Revision 5</b>	March 10, 1999	March 10, 1999	Diamond Aircraft
<b>Revision 6</b>	April 7, 1999	April 7, 1999	Diamond Aircraft
<b>Revision 7</b>	June 21, 1999	June 21, 1999	Diamond Aircraft
<b>Revision 8</b>	December 7, 1999	December 7, 1999	Diamond Aircraft
<b>Revision 9</b>	April 11, 2000	April 11, 2000	Diamond Aircraft
<b>Revision 10</b>	August 14, 2000	August 14, 2000	Diamond Aircraft
<b>Revision 11</b>	May 02, 2001	May 02, 2001	Diamond Aircraft
<b>Revision 12</b>	March 20, 2001	March 20, 2001	Diamond Aircraft
<b>Revision 13</b>	May 28, 2001	May 28, 2001	Diamond Aircraft
<b>Revision 14</b>	August 9, 2001	August 9, 2001	Diamond Aircraft
<b>Revision 15</b>	April 23, 2002	April 23, 2002	Diamond Aircraft
<b>Revision 16</b>	October 18, 2002	October 18, 2002	Diamond Aircraft
<b>Revision 17</b>	March 19, 2004	March 19, 2004	Diamond Aircraft
<b>Revision 18</b>	March 22, 2005	March 22, 2005	Diamond Aircraft
<b>Revision 19</b>	June 24, 2005	June 24, 2005	Diamond Aircraft
<b>Revision 20</b>	August 18, 2005	August 18, 2005	Diamond Aircraft
<b>Revision 21</b>			
<b>Revision 22</b>			
<b>Revision 23</b>			

## SUBSCRIPTION SERVICE

### Diamond Aircraft Publications Revision Subscription Contacts

To ensure safe operation and maintenance of the DA20-C1 aircraft, it is recommended that operators verify that their documentation is at the correct issue/revision levels. For revision and subscription service please contact the following:

#### 1. DA20-C1 related manuals and publications.

**North America, Australia and Africa:**

Diamond Aircraft Industries Inc.  
Customer Support  
1560 Crumlin Sideroad  
London, Ontario  
Canada  
N5V 1S2

Phone: 519 457-4041

Fax: 519 457-4060

**Other:**

Diamond Aircraft Industries GmbH  
Customer Support  
N.A. Otto-Strasse 5  
A-2700 Wiener Neustadt  
Austria

Phone: + 43-(0) 2622-26700

Fax: + 43-(0) 2622-26780

#### 2. Teledyne Continental Motors IO 240B related manuals and publications.

**North America:**

Teledyne Continental Motors  
P.O. Box 90  
Mobile, Alabama  
36601  
Phone: 334 438-3411

**Other:**

Contact a local Teledyne Continental Motors distributor.

#### 3. Hoffman Propeller Model HO 14HM-175-157 related manuals and publications.

**North America and Australia:**

Diamond Aircraft Industries Inc.  
Customer Support  
1560 Crumlin Sideroad  
London, Ontario  
Canada  
N5V 1S2

Phone: 519 457-4041

Fax: 519 457-4045

**Other:**

Hoffman Propeller  
Customer Support  
Kupferlingstr. 9  
D-83022 Rosenheim  
Germany

Phone: + 49-(0) 8031-18780

Fax: + 49-(0) 8031-187878

#### 4. Sensenich Propeller Model W69EK7-63, W69EK7-63G, W69EK-63 related manuals and publications.

**North America:**

Sensenich Wood Propeller Company  
2008 Wood Court  
Plant City, Florida  
USA

Phone: 813 752-3711

Fax: 813 752-2818

---

## CHAPTER 1

### GENERAL

<b>1.1. INTRODUCTION</b>	<b>1- 1</b>
<b>1.2. CERTIFICATION BASIS</b>	<b>1- 2</b>
<b>1.3. WARNINGS, CAUTIONS, AND NOTES</b>	<b>1- 2</b>
<b>1.4. THREE-VIEW-DRAWING OF AIRPLANE</b>	<b>1- 3</b>
<b>1.5. DIMENSIONS</b>	<b>1- 4</b>
<b>1.6. ENGINE</b>	<b>1- 5</b>
<b>1.7. PROPELLER</b>	<b>1- 5</b>
<b>1.8. FUEL</b>	<b>1- 5</b>
<b>1.9. LUBRICANT AND COOLANT</b>	<b>1- 6</b>
<b>1.10. WEIGHT</b>	<b>1- 8</b>
<b>1.11. LIST OF DEFINITIONS AND ABBREVIATIONS</b>	<b>1- 9</b>
<b>1.12. CONVERSION FACTORS</b>	<b>1-13</b>

#### 1.1. INTRODUCTION

The Airplane Flight Manual has been prepared to provide pilots and instructors with information for the safe and efficient operation of this airplane.

This Manual includes the material required by JAR-VLA and Transport Canada Airworthiness Manual (AWM) Chapter 523-VLA. It also contains supplemental data supplied by the airplane manufacturer which can be useful to the pilot.

The Flight Manual conforms to a standard equipped DA 20-C1 KATANA. Any optional equipment installed on request of the customer (COMM, NAV, etc.) is not considered.

For the operation of optional equipment the Operation Manual of the respective vendor must be used.

For permissible accessories refer to the equipment list, Section 6.5.

## 1.2. CERTIFICATION BASIS

The DA 20-C1 has been approved by Transport Canada in accordance with the Canadian Airworthiness Manual (AWM) Chapter 523-VLA., Type Certificate No. A-191.

Category of Airworthiness: UTILITY  
Noise Certification Basis: a) Canadian Airworthiness Manual Chapter 516  
b) FAA Part 36  
c) ICAO Annex 16

## 1.3. WARNINGS, CAUTIONS, AND NOTES

The following definitions apply to warnings, cautions, and notes used in the Flight Manual:

### **WARNING**

means that the non-observation of the corresponding procedure leads to an immediate or important degradation of the flight safety.

### **CAUTION**

means that the non-observation of the corresponding procedure leads to a minor or to a long term degradation of flight safety.

### **NOTE**

draws the attention to any special item not directly related to safety but which is important or unusual.

### 1.4. THREE-VIEW-DRAWING OF AIRPLANE

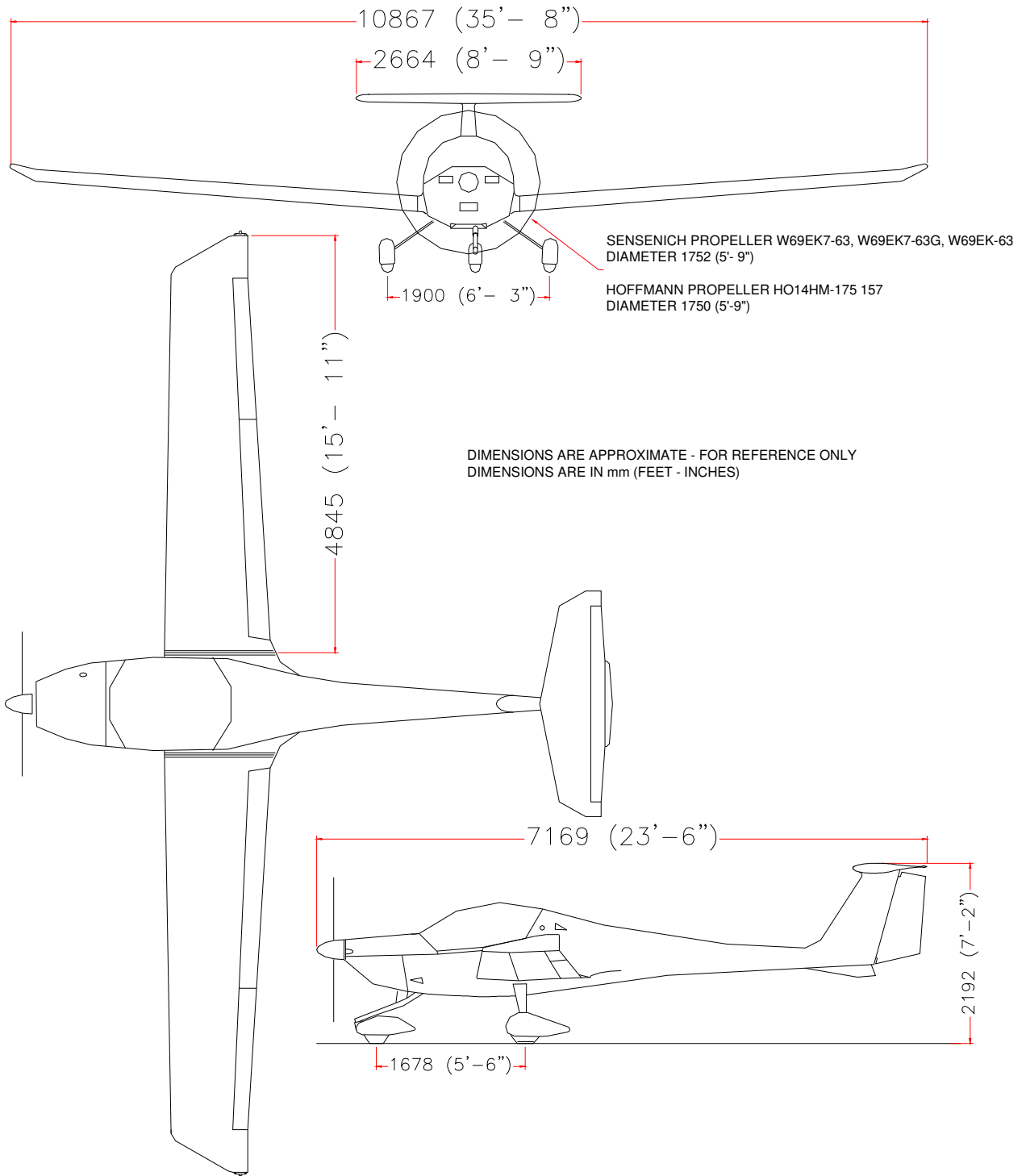

## 1.5. DIMENSIONS

### 1.5.1 Overall Dimensions

Span:	35 ft 8 in ( 10.87 m)
Length:	23 ft 6 in ( 7.17 m)
Height:	7 ft 2 in ( 2.19 m)

### 1.5.2 Wing

Airfoil:	Wortmann FX 63-137/20 HOAC
Wing Area:	125 sq ft ( 11.6 m <sup>2</sup> )
Mean Aerodynamic Chord (MAC):	3 ft 6.9 in ( 1.09 m)
Aspect Ratio:	10.0
Dihedral:	+4° nominal
Sweep of Leading Edge:	+1° nominal

### 1.5.3 Horizontal Stabilizer

Angle of Incidence :	-4° ±0.5°
Span:	8 ft 9 in ( 2.66 m)

### 1.5.4 Landing Gear

Track:	6 ft 3 in (1.90 m)
Wheel Base:	5 ft 6 in (1.68 m)
Tire Size:	Nose: 5.00-4, 6 ply Main: 5.00-5, 6 ply
Tire Pressure:	Nose: 26 psi (1.8 bar) Main: 33 psi (2.3 bar)



## 1.6. ENGINE

Continental IO 240, naturally aspirated, 4 cylinder, 4 stroke-engine, fuel injected, horizontally opposed, air cooled.

Propeller drive direct from engine crankshaft.

Displacement:	239.8 cu.in. (3.9 liters)
Output Power:	125 hp (93.2 kW)
at	2800 RPM

## 1.7. PROPELLER

Two-bladed fixed pitch propeller,  
manufactured by HOFFMANN,

Model HO-14HM-175-157

Diameter:

5 ft 8.9 in (1.75 m)

Two-bladed fixed pitch propeller,  
manufactured by Sensenich,

Model W69EK7-63, W69EK7-63G or  
W69EK-63

Diameter:

5 ft 9 in (1.752 m)

## 1.8. FUEL

Approved Fuel Grades: AVGAS 100 or 100LL

Total Fuel Capacity: 24.5 US gal. (93 liters)

Usable Fuel: 24.0 US gal. (91 liters)

Unusable Fuel: 0.5 US gal. ( 2 liters)

## 1.9. LUBRICANT AND COOLANT

### 1.9.1. Lubricant

Use only lubricating oils conforming to TCM specification MHS24. See table 1 below for approved brands,

<b>SUPPLIER</b>	<b>BRAND (if applicable)</b>	<b>TYPE (if applicable)</b>
BP Oil Corporation	BP Aero Oil	-
Castrol Limited ( Australia )	Castrolaero AD Oil	-
Cheveron U.S.A. Inc.	Cheveron Aero Oil	-
Continental Oil	Conco Aero S	-
Delta Petroleum Company	Delta Avoil Oil	-
Exxon Company, U.S.A.	Exxon Aviation Oil EE	-
Gulf Oil Company	Gulfpride Aviation AD	-
Mobil Oil Company	Mobil Aero Oil	-
NYCO S.A.	TURBONYCOIL 3570	-
Pennzoil Company	Pennzoil Aircraft Engine Oil	-
Phillips Petroleum Company	Phillips 66 Aviation Oil	Type A
Phillips Petroleum Company	*X/C Aviation Multiviscosity Oil	SAE 20W50, SAE 20W60
Quaker State Oil & Refining Co.	Quaker State AD Aviation Engine OIL	-
Red Ram Limited ( Canada )	Red Ram X/C Aviation Oil	20W50
Shell Australia	Aeroshell (R) W	-
Shell Canada Limited	Aeroshell Oil W, Anti-Wear Formulation Aeroshell Oil	15W50 15W50
Shell Oil Company	-	-
Sinclair Oil Company	-	-
Texaco Inc.	-	-
Total France	-	-
Union Oil Company of California	-	-

**Table 1**

The viscosity should be selected according to the various climatic conditions using table 2.

Use only the oils specified TCM specification MHS 24

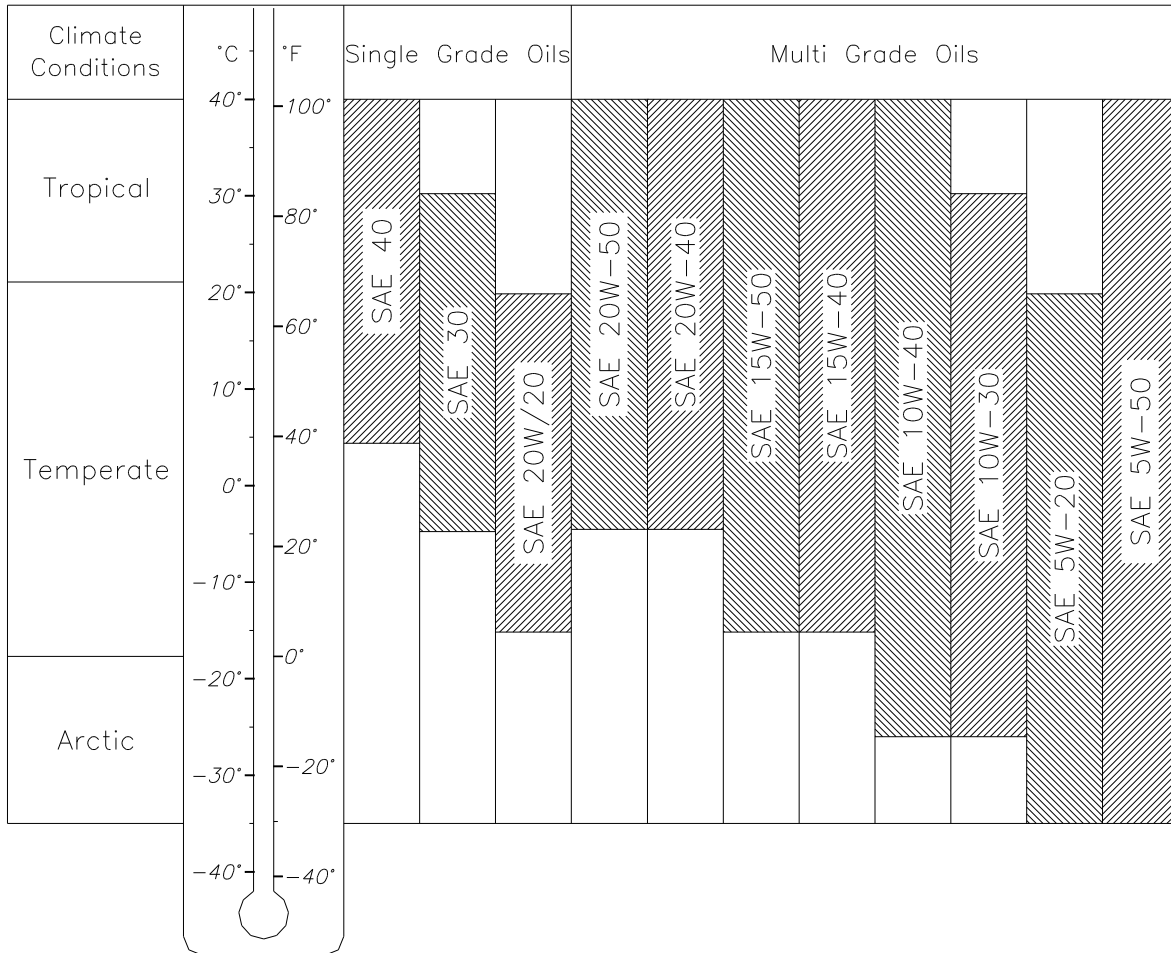

**Table 2**

Oil Capacity:      Maximum : 6.0 US qt (5.68 liters.)  
                          Minimum : 4.0 US qt (3.78 liters.)

---

## 1.10. WEIGHT

Maximum Ramp Weight	: 1660 lbs (753 kg)
Maximum Take-off Weight	: 1653 lbs (750 kg)
Maximum Landing Weight	: 1653 lbs (750 kg)
Empty Weight	: See Chapter 6
Maximum Weight in Baggage Compartment	: 44 lbs (20 kg) only if restraining devices available

### Wing Loading

At Maximum Take-off Weight	: 13.21 lbs/sq.ft. (64.52 kg/m <sup>2</sup> )
Performance Load at Max. Take-off Weight	: 13.22 lbs/hp (8.04 kg/kW)

---

## 1.11. LIST OF DEFINITIONS AND ABBREVIATIONS

### 1.11.1. Speed

AGL: Above Ground Level

CAS: Calibrated airspeed; Indicated speed corrected for installation and instrument errors. CAS is equal to TAS at standard atmospheric conditions at MSL.

KCAS: CAS in knots.

IAS: Indicated airspeed as shown on the airspeed indicator.

KIAS: IAS indicated in knots.

GS: Ground Speed. Speed of the airplane relative to the ground.

TAS: True airspeed. Speed of the airplane relative to air. TAS is CAS corrected for altitude and temperature errors.

$v_A$ : Maneuvering speed. Maximum speed at which the airplane is not overstressed at full deflection of control surfaces.

$V_{FE}$ : Maximum speed with flaps extended.

$v_{NE}$ : Speed which must never be exceeded in any operation.

$v_{NO}$ : Maximum structural cruising speed which should only be exceeded in calm air, and then only with caution.

$v_S$ : The power-off stall speed with the airplane in its standard configuration.

$v_{SO}$ : The power-off stall speed with the airplane in landing configuration.

$v_X$ : Best angle-of-climb speed.

$v_Y$ : Best rate-of-climb speed.

### 1.11.2. Meteorological Terms

ISA: International Standard Atmosphere at which air is identified as a dry gas. The temperature at mean sea level is 15° Celsius (59° F), the air pressure at sea level is 1013.25 mbar (29.92 inHg), the temperature gradient up to the altitude at which the temperature reaches -56.5° C (-67.9° F) is -0.0065° C/m (-0.0036° F/ft) and 0° C/m (0° F/ft) above.

OAT: Outside air temperature.

AGL: Above Ground Level

Indicated Pressure Altitude:

Altitude reading with altimeter set to 1013.25 mbar (29.92 inHg) air pressure.

Pressure Altitude:

Altitude measured at standard pressure at MSL (1013.25 mbar / 29.92 inHg) using a barometric altimeter. Pressure altitude is the indicated altitude corrected for installation and instrument errors. Within this manual the instrument errors are assumed to be zero.

Aerodrome/Airport Pressure:

Actual atmospheric pressure at the aerodrome/airport altitude.

Wind: The wind speeds used in the diagrams in this manual should be referred to as headwind or tailwind components of the measured wind.

### 1.11.3. Powerplant

Take-off Power:

Maximum engine power for take-off.

Maximum Continuous Power:

Maximum permissible continuous engine output power during flight.

#### 1.11.4. Flight Performance and Flight Planning

Demonstrated Crosswind Component:

The max. speed of the crosswind component at which the manoeuvrability of the airplane during take-off and landing has been demonstrated during type certification test flights.

Service Ceiling:

The altitude at which the maximum rate of climb is 0.5 m/s (100 ft/min.).

#### 1.11.5. Weight and Balance

Reference Datum (RD):

An imaginary vertical plane from which all horizontal distances for the center of gravity calculations are measured. It is the plane through the leading edge of the wing root rib, perpendicular to the longitudinal axis of the airplane.

Station:

A defined point along the longitudinal axis which is generally presented as a specific distance from the reference datum.

Lever Arm:

The horizontal distance from the reference datum to the center of gravity (of a component).

Moment:

The weight of a component multiplied by its lever arm.

Center of Gravity (CG):

Point of equilibrium for the airplane weight.

CG position:

---

Distance from the reference datum to the CG. It is determined by dividing the total moment (sum of the individual moments) by the total weight.

**Center of Gravity Limits:**

The CG range which an airplane with a given weight must be operated within.

**Usable Fuel:**

The amount of fuel available for the flight plan calculation.

**Unusable Fuel:**

The amount of fuel remaining in the tank, which cannot be safely used in flight.

**Empty Weight:**

Weight of the airplane including unusable fuel, all operating fluids and maximum amount of oil.

**Useful Load:**

The difference between take-off weight and empty weight.

**Maximum Take-off Weight:**

Maximum weight permissible for take-off.

**1.11.6. Equipment**

ACL: Anti collision light

**1.11.7 Miscellaneous**

GFRP - Glass Fibre Reinforced Plastic

CFRP - Carbon Fibre Reinforced Plastic



## 1.12. CONVERSION FACTORS

### 1.12.1. Length or Altitude

$$1 \text{ [ft.]} = 0.3048 \text{ [m]}$$

$$1 \text{ [in.]} = 25.4 \text{ [mm]}$$

### 1.12.2. Speed

$$1 \text{ [kts]} = 1.852 \text{ [km/h]}$$

$$1 \text{ [mph]} = 1.609 \text{ [km/h]}$$

### 1.12.3. Pressure

$$1 \text{ [hPa]} = 100 \text{ [N/m}^2\text{]} = 1 \text{ [mbar]}$$

$$1 \text{ [in. Hg]} = 33.865 \text{ [hPa]}$$

$$1 \text{ [psi]} = 68.97 \text{ [mbar]}$$

### 1.12.4 Weight

$$1 \text{ [lbs]} = 0.454 \text{ [kg]}$$

### 1.12.5 Volume

$$1 \text{ [US gallon]} = 3.785 \text{ [liters]}$$

$$1 \text{ [Imperial gallon]} = 4.546 \text{ [liters]}$$

#### CONVERSION/CHART LITERS/ US GALLONS

Liter	US Gallon	US Gallon	Liter
5	1.3	1	3.8
10	2.6	2	7.6
15	4.0	4	15.1
20	5.3	6	22.7
25	6.6	8	30.3
30	7.9	10	37.9
35	9.2	12	45.4
40	10.6	14	53.0
45	11.9	16	60.6
50	13.2	18	68.1
60	15.9	20	75.7
70	18.5	22	83.3
80	21.1	24	90.9
90	23.8	26	98.4
100	26.4	28	106.0

## CHAPTER 2

# OPERATING LIMITATIONS

2.1	INTRODUCTION	2-1
2.2	AIRSPEED LIMITATIONS	2-2
2.3	AIRSPEED INDICATOR MARKINGS	2-2
2.4	POWER PLANT LIMITATIONS	2-3
2.5	POWERPLANT INSTRUMENT MARKINGS	2-5
2.6	MISCELLANEOUS INSTRUMENT MARKINGS	2-5
2.7	WEIGHT	2-6
2.8	CENTER OF GRAVITY	2-6
2.9	APPROVED MANEUVERS	2-7
2.10	MANEUVERING LOAD FACTORS	2-8
2.11	MAXIMUM PASSENGER SEATING	2-9
2.12	FLIGHT CREW	2-9
2.13	KINDS OF OPERATION	2-9
2.14	FUEL	2-10
2.15	PLACARDS	2-10
2.16	DEMONSTRATED CROSSWIND COMPONENT	2-19
2.17	TEMPERATURE LIMITS	2-19

## 2.1 INTRODUCTION

Chapter 2 of this Flight Manual comprises of the operating limitations, instrument markings, airspeed indicator markings, and the limitation placards which are necessary for the safe operation of the airplane, its engine, and standard systems and equipment.

The operating limitations in this Chapter and Chapter 9 have been approved by the Department of Transport (DOT), and must be complied with for all operations.

### WARNING

All limitations given in this chapter must be complied with for all operations.

## 2.2 AIRSPEED LIMITATIONS

Speed	KIAS	Remarks
<b>V<sub>A</sub></b> <b>Maneuvering Speed.</b>	106	Do not make full or abrupt control movement above this speed. Under certain conditions the airplane may be overstressed by full control movement.
<b>V<sub>FE</sub></b> <b>Maximum Flap Extended Speed.</b>		
<b>V<sub>FE</sub> (T/O)</b>	100	Do not exceed this speed with flaps in take-off position.
<b>V<sub>FE</sub> (LDG)</b>	78	Do not exceed this speed with flaps in landing position.
<b>V<sub>NO</sub></b> <b>Maximum Structural Cruising Speed.</b>	118	Do not exceed this speed except in smooth air, and then only with caution.
<b>V<sub>NE</sub></b> <b>Never Exceed Speed.</b>	164	Do not exceed this speed in any operation.

## 2.3 AIRSPEED INDICATOR MARKINGS

Marking	KIAS	Explanation
<b>White Arc</b>	34-78	Operating range with extended flaps
<b>Green Arc</b>	42-118	Normal operating range
<b>Yellow Arc</b>	118-164	Maneuvers must be conducted with caution and only in smooth air.
<b>Red Line</b>	164	Maximum permissible speed for all operating modes

## 2.4 POWER PLANT LIMITATIONS

### 2.4.1 Engine

- (a) **Engine Manufacturer** : Teledyne Continental Motors  
 (b) **Engine Type Designation** : IO-240-B

#### (c) Engine Operating Limitations

- Max. T/O Power (5 min.) : 125 BHP / 93.2 kW  
 Max. Permissible T/O RPM : 2800 RPM

- Max. Continuous Power : 125 BHP / 93.2 kW  
 Max. Permissible Continuous RPM : 2800 RPM

#### (d) Oil Pressure

- Minimum : 10 psi (1.5 bar)  
 Maximum : 100 psi (6.9 bar)  
 : Ambient temperature below 32°F (0°C), Full power operation oil pressure 70 psi max  
 Normal Operating : 30 psi (2.1 bar) to 60 psi (4.1 bar)

#### (e) Intentionally left blank

#### (f) Oil Temperature

- Minimum : 75°F (24°C)  
 : Full power operation, oil pressure normal 100°F (38°C)  
 Maximum : 240°F (115°C)

**(g) Cylinder Head Temperature**

Maximum 460°F (238°C)  
 Minimum : 240°F (115°C) takeoff and descent

**(h) Fuel Specifications**

Approved Fuel Grades : AVGAS 100LL or 100

**(i) Oil Grades** Reference TCM IO-240-B operator and installation manual (form X30620) or TCM specification MHS-24. Refer to Chap. 1, Section 1.9.1 Lubricant, Table 1.

**2.4.2 Additional for aircraft equipped with altitude compensating fuel system.**

**(a) Mandatory Preflight Idle Mixture Rise:** 50 RPM Minimum: See Normal Procedures-Before Takeoff (Section 4.4.6)

<b>NOTE</b>
-------------

Less than 50 RPM Mixture Rise indicates an excessively lean idle mixture that can result in engine stoppage at idle.

**(b) Minimum Ground Idle Speed:** 975 RPM Minimum

<b>NOTE</b>
-------------

Recommended minimum flight idle speed 1400 RPM, during idle power flight conditions and maneuvers.

**2.4.3 Propellers****HOFFMANN**

- (a) Propeller Manufacturer** : Hoffmann Propeller, Rosenheim/Germany
- (b) Propeller Type** : Fixed Pitch HO-14HM-175-157
- (c) Propeller Diameter** : 68.9 inch (1750mm)
- (d) Propeller Pitch (at 3/4 radius)** : 61.8 inch (1570mm)

**SENENICH**

- (a) Propeller Manufacturer** : Sensenich Propeller, Plant City/Florida
- (b) Propeller Type** : Fixed Pitch W69EK7-63, W69EK7-63G or W69EK-63
- (c) Propeller Diameter** : 69.0 inch (1752mm)
- (d) Propeller Pitch (at 3/4 radius)** : 62.8 inch (1595mm)

## 2.5 POWERPLANT INSTRUMENT MARKINGS

Powerplant instrument markings and their color code significance are shown below:

Instrument	Red Line = Lower Limit	Green Arc = Normal Operating Range	Yellow Arc = Caution Range	Red Line = Upper Limit
Tachometer	-	700 - 2800 RPM	-	2801 RPM
Oil Temperature Indicator	75° F	170 - 220° F	75-170° F 220 -240° F	240° F
Cylinder Head Temperature Indicator	-	360-420° F	240-360° F 420-460° F	460° F
Oil Pressure Indicator	10 psi	30-60 psi	10-30 psi 60-100 psi	100 psi
Fuel Pressure Indicator	3.5 psi	-	-	16.5 psi
	3.5 psi	-	-	32.5 psi *

\* Aircraft with manifold valve fuel vapour separator system.

Powerplant instrument markings for instruments delivered after July 1999.

Oil Temperature Indicator	75° F	170 - 220° F	-	240° F
Cylinder Head Temperature Indicator	-	300-420° F	420-460° F	460° F
Oil Pressure Indicator	10 psi	30-60 psi	-	100 psi

## 2.6 MISCELLANEOUS INSTRUMENT MARKINGS

Instrument	Red Arc = Lower Limit	Green Arc = Normal Operating Range	Yellow Arc = Caution Range	Red Line = Upper Limit
Voltmeter	8-11 Volts	12.5 - 16 Volts	11 - 12.5 Volts	16.1 Volts

## 2.7 WEIGHT

Maximum Ramp Weight	: 1660 (753 kg)
Maximum Take-off Weight	: 1653 lbs (750 kg)
Maximum Landing Weight	: 1653 lbs (750 kg)
	:
Maximum permissible weight in the baggage compartment	: 44 lbs ( 20 kg) only permissible with baggage harness

### WARNING

Exceeding weight limitations may lead to overloading of the airplane and cause loss of control of the airplane and/or structural damage.

## 2.8 CENTER OF GRAVITY

The reference datum (RD) for the center of gravity (CG) calculation is tangent to the leading edge of the wing at the root rib. This plane is vertical when the fuselage is horizontal. Procedures for horizontal alignment, as well as particulars with regard to the empty weight center of gravity, refer to Chapter 6.

Most forward CG (all weights)	: 7.96 in (202 mm) aft of RD.
Most rearward CG (all weights)	: 12.49 in (317 mm) aft of RD.

### WARNING

Exceeding the center of gravity limitations reduces the maneuverability and stability of the airplane.

The procedure used to determine the center of gravity is described in Chapter 6.

## 2.9 APPROVED MANEUVERS

This airplane is certified in the UTILITY Category in accordance with Canadian Airworthiness Manual Chapter 523-VLA.

Permissible Utility Category Maneuvers:

- a) All normal flight maneuvers
- b) Lazy Eight's                      Entry speed: 116 KIAS  
Chandelles:                      Entry speed: 116 KIAS  
Steep turns in which the angle of bank does not exceed 60
- c) Spinning NOT approved for aircraft equipped with altitude compensating fuel system.
- d) Spinning (with Wing Flaps UP) approved for aircraft NOT equipped with altitude compensating fuel system.
- e) Stalls NOT approved for aircraft equipped with altitude compensating fuel system and not in compliance with MSB DAC1-73-05 latest approved revision.
- f) Stalls (except whip stalls) approved for aircraft NOT equipped with altitude compensating fuel system
- g) Stalls (except whip stalls) approved for aircraft equipped with altitude compensating fuel system in compliance with MSB DAC1-73-05 latest approved revision.
- h) Intentional Side Slips, except as required for landings, NOT approved for aircraft equipped with altitude compensating fuel system and not in compliance with MSB DAC1-73-05 latest approved revision.

<b>NOTE</b>
-------------

Aerobatics are prohibited.



## 2.10 MANEUVERING LOAD FACTORS

Table of structural maximum permissible load factors:

	at $v_A$ :	at $v_{NE}$ :	with flaps in T/O or LDG position
<b>Positive</b>	+ 4.4	+ 4.4	+ 2.0
<b>Negative</b>	- 2.2	- 2.2	0

### **WARNING**

Exceeding the maximum load factors will result in overstressing of the airplane. Simultaneous full deflection of more than one control surface can result in overstressing of the structure, even at speeds below the maneuvering speed.

## 2.11 MAXIMUM PASSENGER SEATING

Maximum Passenger Seating: one passenger.

## 2.12 FLIGHT CREW

Minimum Flight Crew: one pilot,

## 2.13 KINDS OF OPERATION

Flights are permissible in accordance with visual flight rules.

Minimum Equipment, Flight and Navigation Instruments:

Airspeed Indicator

Altimeter

Magnetic Compass

Turn and Bank Indicator (not mandatory for Day-VFR only)

Instrument Panel and Map Lighting (not mandatory for Day-VFR only)

Directional Gyro (not mandatory for Day-VFR only)

Minimum Equipment, Powerplant Instruments:

Fuel Quantity Indicator

Fuel Pressure Indicator

Oil Pressure Indicator

Oil Temperature Indicator

Exhaust Gas Temperature

Cylinder Head Temperature Indicator

Tachometer

Voltmeter

Ammeter

Generator Warning Light

Note: Additional equipment may be required for compliance with specific operational or specific national requirements. It is the operators responsibility to ensure compliance with any such specific equipment requirements.

## 2.14 FUEL

### Fuel Capacity

- Total Fuel Quantity: : 24.5 US gal. ( 93.0 liters)
- Usable Fuel: : 24.0 US gal. ( 91.0 liters)
- Unusable Fuel: : 0.5 US gal. ( 2.0 liters)

## 2.15 PLACARDS

The following placards must be installed:

### 1. On the instrument panel above the tachometer.

This airplane is classified as a very light airplane approved for VFR only, in non-icing conditions. All aerobatic maneuvers, except for intentional spinning which is permitted with flaps UP only are prohibited. See Flight Manual for other limitation.

**OR**

This airplane is classified as a very light airplane approved for Visual Meteorological Conditions only, in non-icing conditions. All aerobatic maneuvers, except for intentional spinning which is permitted with flaps UP only are prohibited. See Flight Manual for other limitations.

### 2. On the flap controller.

CRUISE  
T/O  
LDG

CRUISE  
T/O  
LDG

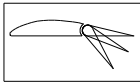

Flaps

### 3. On the upper instrument panel around the trim

NOSE UP  
  
NEUTRAL  
  
NOSE DOWN

TRIM  

### 4. On the instrument panel below the airspeed indicator.

Maneuvering speed  $V_A = 106\text{kts}$

### 5. On the instrument panel below the tachometer

GPS limited for VFR only.

### 6. On the fuel quantity indicator

Usable  
91 L/24 US gal.

### 7. On the instrument panel in the pilots direct line of sight.

No smoking!

### 8. On the instrument panel below the switches on the left hand side or on the front face of the pilots seat





13. On the exterior of the canopy frame on the L/H side. And on the interior of the canopy frame on the R/H side.

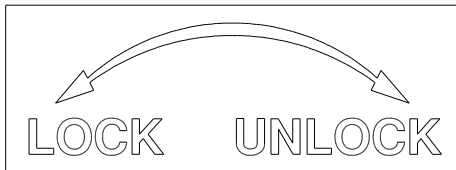

14. On the exterior of the canopy frame on the R/H side. And on the interior of the canopy frame on the LH side.

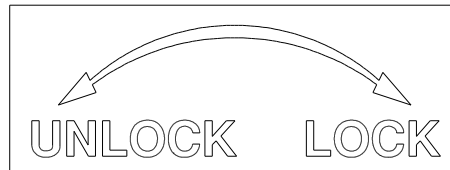

15. On the exterior of the canopy frame on the R/H and L/H side.



16. On the interior of the canopy frame on the R/H and L/H side.



17. On the exterior of the canopy frame on the L/H side (If equipped with outside handle).

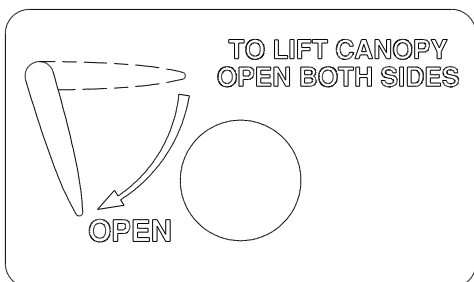

18. On the exterior of the canopy frame on the R/H side (If equipped with outside handle).

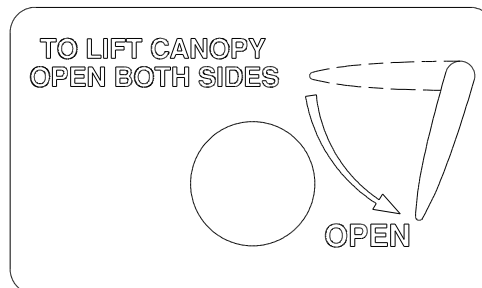

19. On the interior of the canopy frame on the L/H side (If equipped with outside handle).

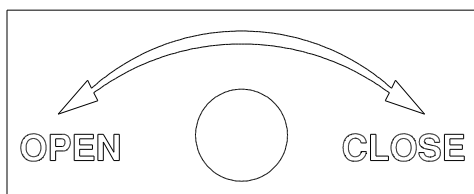

20. On the interior of the canopy frame on the R/H side (If equipped with outside handle).

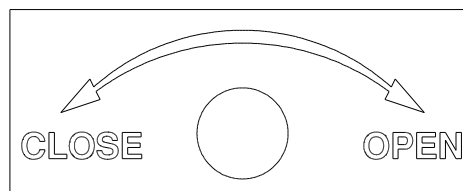

21. On the exterior of the canopy frame on the L/H side (If equipped with lock).

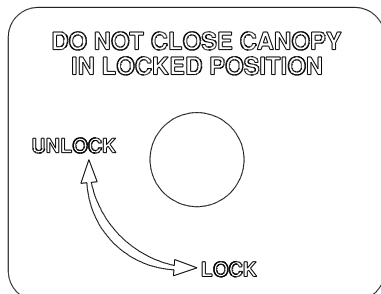

22. On the interior of the canopy frame on the R/H and L/H side (If equipped with outside handle).



23. On the L/H side of the canopy sill.

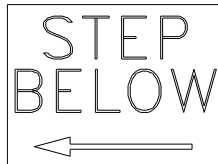

24. On the R/H side of the canopy sill.

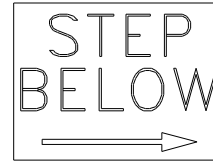

25. On the R/H upper fuselage behind the canopy, if an ELT is installed.



26. Next to the fuel filler cap

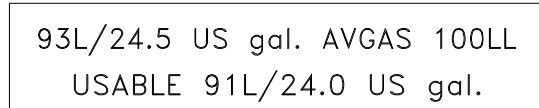

27. Next to the fuel filler cap

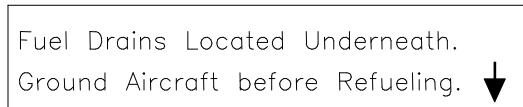

28. On the fuselage underside (belly), near the center line between the wings.

MAINTENANCE  
FUEL DRAINS

29. On the underside of the fuselage (belly), to the left just forward of the wing trailing edge.

FUEL DRAINS

30. On the inside of the oil filler door.

**CAUTION**  
USE ONLY AVIATION  
GRADE OIL !  
OIL 6.0 US Qts.  
5.68 l  
SAE 20W-50  
OR ACCORDING TO  
FLIGHT MANUAL

31. On the upper L/H fuselage near the wing trailing edge.

REFUELING  
GROUND

32. Under each wing and on the tail skid.

TIE DOWN

33. On the underside of the fuselage (belly) near the L/H wing trailing edge

GROUND  
HERE

34. On the L/H side of the fuselage below the vertical stabilizer.

*Diamond* AIRCRAFT INDUSTRIES  
LONDON, ONTARIO, CANADA  
MODEL NO. : DA 20-C1  
SERIAL NO. :  
DATE MFD. :  
TYPE CERT. : A-191

OR

**Diamond** AIRCRAFT INDUSTRIES  
LONDON, ONTARIO, CANADA  
MODEL NO. : DA20-C1  
SERIAL NO. :  
TYPE CERT. : CAN. A-191  
US TA4CH

35. On the nose landing gear strut

1.8 bar  
26 psi  
180 kPa

36. On the main landing gear strut.

2.3 bar  
33 psi  
230 kPa

37. On the upper engine cowling behind the propeller spinner.

38. Around the stall warning hole in the left wing.

DO NOT PUSH ON SPINNER



39. Around the co-pilot headset jacks on the back rest.

40. Around the pilot headset jacks on the back rest.

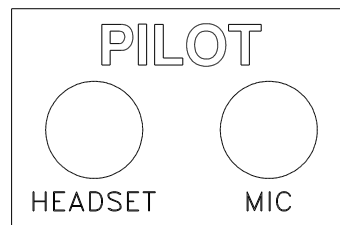
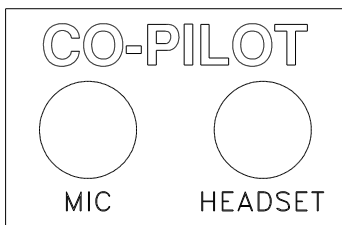

41. Next to the ELT (if installed) to indicate the switch position.

42. On the L/H side of the baggage compartment.

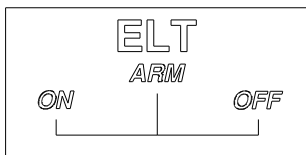

For ELT model EBC 502

MAX. BAGGAGE - 44 lbs (20kg)  
ONLY WITH BAGGAGE NET

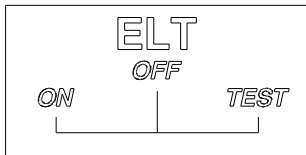

For ELT model EBC 102A

43. On the R/H side of the center console under the throttle.

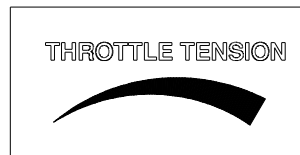

44. On the brake fluid reservoirs

HYDRAULIC FLUID  
MIL-H-5606



**45a On the engine controls on the center console.**

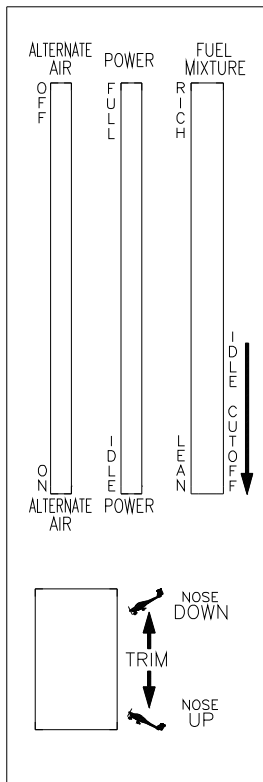

**45b.**

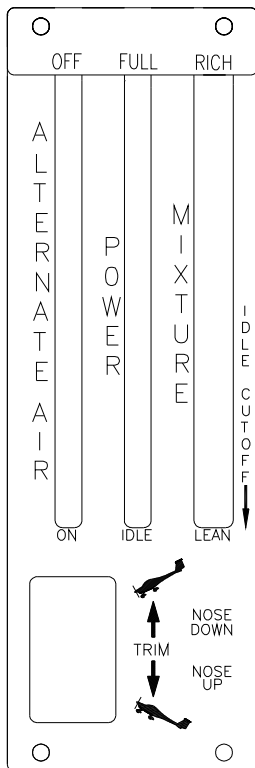

**45c.**

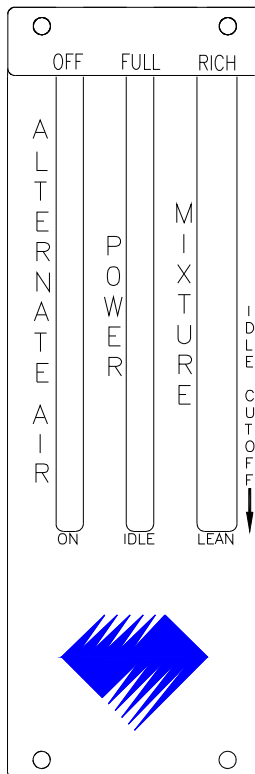

**45d.**

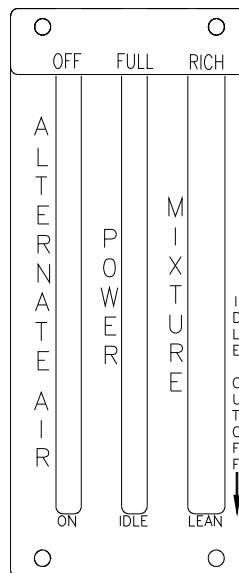

**46a On the center console on the heating and parking brake controls.**

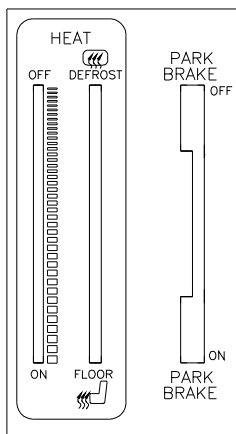

**46b.**

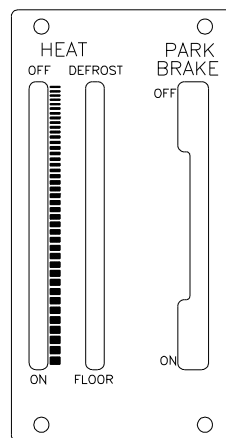

47 On the left side of the instrument panel near the top.

CAUTION!  
GROUND  
OPERATION.  
DO NOT ENGAGE  
STARTER WHEN  
PROPELLER  
IS MOVING.  
SERIOUS ENGINE  
DAMAGE MAY  
RESULT.

48 On the engine controls for aircraft with center console mounted Fuel Selector.

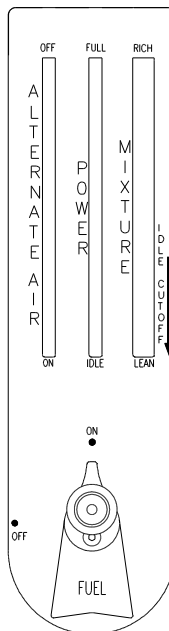

49 On the instrument panel on Aircraft equipped with supplemental lighting (MOD 32).

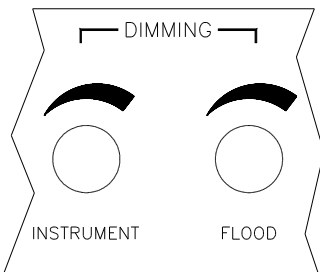

50. On fuel shut-off handle on R/H side of the center console. For aircraft with instrument panel mounted fuel selector.



51. Around the ignition switch on the instrument panel.

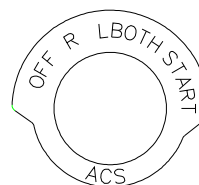

52. On the back-rest on the right side.



**53. On the Instrument Panel.**

For Idle Power Operation:

1. Fuel Pump	ON
2. Mixture	FULL RICH
3. Throttle	IDLE

**54. Adjacent to the flap controller.**

$V_{FE}$  (T/O) 100 KTS.  
 $V_{FE}$  (LDG) 78 KTS.

**55. On the instrument panel**

if equipped with altitude compensating fuel pump.

This aircraft is equipped with an altitude compensating fuel system. See AFM Chapter 2, 4, & 7 for limitation and operating instructions.

**56. On the instrument panel**

if equipped with altitude compensating fuel pump.

GROUND IDLE SPEED:  
975 RPM MINIMUM

IDLE MIXTURE RISE:  
50 RPM MINIMUM

RECOMMENDED MINIMUM FLIGHT  
IDLE SPEED: 1400 RPM

**57. On the instrument panel**

if equipped with altitude compensating fuel pump

This airplane is classified as a very light airplane approved for Visual Meteorological Conditions only, in non-icing conditions. All aerobatic maneuvers, including intentional spinning are prohibited. See Flight Manual for other limitations.

**2.16 DEMONSTRATED CROSSWIND COMPONENT**

The maximum demonstrated crosswind component is 20 kts. (37 km/h).

**2.17 TEMPERATURE LIMITS****CAUTION**

For aircraft with other than white undersides. Parking the aircraft over a light coloured or reflective surface in conditions of bright sunlight, particularly at high OAT, is not recommended.

Temperature limit of the structure for the operation of the airplane:

Maximum T/O Temperature :

131°F (55°C)

Structural Temperature

## CHAPTER 3

### EMERGENCY PROCEDURES

<b>3.1.</b>	<b>INTRODUCTION</b>	<b>3- 2</b>
<b>3.2.</b>	<b>AIRSPEDS DURING EMERGENCY PROCEDURES</b>	<b>3- 2</b>
<b>3.3.</b>	<b>EMERGENCY PROCEDURES - CHECKLISTS</b>	
<b>3.3.1.</b>	<b>Engine Failures</b>	
	(a) Engine Failure during Take-off Run	3- 3
	(b) Engine Failure after Take-off	
	I. Insufficient Engine Power	3- 3
	II. Engine Inoperative	3- 4
	(c) Engine Failure during Flight	
	I. Engine Running Roughly	3- 4
	II. Loss of Oil Pressure	3- 4
	III. Loss of Fuel Pressure	3- 4
	IV. Restarting the Engine with Propeller Windmilling	3- 5
	V. Restarting the Engine with Propeller at Full Stop	3- 6
<b>3.3.2.</b>	<b>Gliding</b>	<b>3- 6</b>
<b>3.3.3.</b>	<b>Emergency Landing</b>	
	(a) Emergency Landing with Engine Off	3- 7
	(b) Precautionary Landing with Engine Power Available	3- 7
<b>3.3.4.</b>	<b>Fire</b>	
	(a) Engine Fire during Start on the Ground	3- 9
	(b) Engine Fire during Flight	3- 9
	(c) Electrical Fire including Smoke during Flight	3- 9
	(d) Electrical Fire including Smoke on the Ground	3-10
	(e) Cabin Fire during Flight	3-10
<b>3.3.5.</b>	<b>Icing</b>	
	Unintentional Flight into Icing Area	3-11
<b>3.3.6.</b>	<b>Recovery from Unintentional Spin</b>	<b>3-11</b>
<b>3.3.7.</b>	<b>Landing with Defective Tire on Main Landing Gear</b>	<b>3-12</b>
<b>3.3.8.</b>	<b>[Intentionally left blank]</b>	<b>3-12</b>
<b>3.3.9.</b>	<b>Electrical Power Failure</b>	<b>3-13</b>
<b>3.3.10</b>	<b>Flap System Failure</b>	<b>3-15</b>
<b>3.3.11</b>	<b>Starter Failure</b>	<b>3-15</b>
<b>3.3.12.</b>	<b>Avionics System Failure</b>	<b>3-16</b>
<b>3.3.13.</b>	<b>Trim System Failure</b>	<b>3-17</b>
<b>3.3.14.</b>	<b>Instrument Panel Lighting Failure</b>	<b>3-18</b>

### 3.1. INTRODUCTION

The following chapter contains check-lists as well as descriptions of the recommended procedures in case of an emergency. However, engine failure or other airplane related emergency situations will most likely never occur if the mandatory pre-flight check and maintenance are performed properly.

In the event that an emergency situation does appear, the procedures presented in this manual should be used to rectify such problems. Since it is impossible to present in the Flight Manual all emergency situations which may occur, knowledge of the airplane and experience of the pilot are essential in rectifying any problems.

### 3.2. AIRSPEEDS DURING EMERGENCY PROCEDURES

	KIAS
Engine failure after take-off with flaps in T/O position	58
Maneuvering Speed	106
Airspeed for best glide angle                      Maximum Gross Weight	
Wing Flaps in CRUISE position                      1720 lbs (780 kg)	73
Precautionary Landing (with power and Wing Flaps in landing position)	52
Emergency landing with engine off (Wing Flaps in T/O position)	58
Emergency landing with engine off (Wing Flaps in LDG position)	52
Emergency landing with engine off (Wing Flaps CRUISE)	62

### 3.3. EMERGENCY PROCEDURES - CHECKLISTS

#### 3.3.1. Engine Failures

##### (a) Engine Failure during Take-off Run

- |    |                       |              |
|----|-----------------------|--------------|
| 1. | Throttle              | IDLE         |
| 2. | Brakes                | as required  |
| 3. | Flaps                 | CRUISE       |
| 4. | Mixture               | IDLE CUT-OFF |
| 5. | Ignition Switch       | OFF          |
| 6. | GEN/BAT Master Switch | OFF          |

##### (b) Engine Failure after Take-Off

###### I. INSUFFICIENT ENGINE POWER

- |    |                     |           |
|----|---------------------|-----------|
| 1. | Airspeed            | 58 KIAS   |
| 2. | Throttle            | FULL      |
| 3. | Mixture             | FULL RICH |
| 4. | Alternate Air       | OPEN      |
| 5. | Fuel Shut-off Valve | OPEN      |
| 6. | Ignition Switch     | BOTH      |
| 7. | Fuel Pump           | ON        |

## WARNING

If adequate engine performance cannot be restored immediately, prepare for an emergency landing. If possible, land straight ahead, avoiding obstacles.

Shortly before landing:

- |     |                       |             |
|-----|-----------------------|-------------|
| 8.  | Mixture               | IDLE CUTOFF |
| 9.  | Fuel Shut-off Valve   | CLOSED      |
| 10. | Ignition Switch       | OFF         |
| 11. | Flaps                 | as required |
| 12. | GEN/BAT Master Switch | OFF         |

II. ENGINE INOPERATIVE

Perform emergency landing according to paragraph 3.3.3.

(c) Engine Failure during Flight

I. ENGINE RUNNING ROUGHLY

- |    |                 |  |
|----|-----------------|--|
| 1. | Mixture         | FULL RICH  |
| 2. | Alternate Air   | OPEN   |
| 3. | Fuel Shut-off   | OPEN   |
| 4. | Fuel Pump       | ON   |
| 5. | Ignition Switch | cycle L - BOTH - R - BOTH  |
| 6. | Throttle        | at present position  |
| 7. | No Improvement  | reduce throttle to minimum required power, land as soon as possible. |

II. LOSS OF OIL PRESSURE

- |    |   |   |
|----|---|---|
| 1. | Oil Temperature   | check   |
| 2. | If Oil Pressure drops below Green Arc but Oil Temperature is normal | land at nearest airfield  |
|    | If Oil Pressure drops below Green Arc and Oil Temperature is rising | reduce throttle to minimum required power; land as soon as possible. Be prepared for engine failure and emergency landing |

III. LOSS OF FUEL PRESSURE

- |    |                                   |   |
|----|-----------------------------------|---|
| 1. | Fuel Pump                         | ON, and land at nearest suitable airport.   |
| 2. | If fuel pressure is not restored. | Land at nearest suitable airport. Be prepared for engine failure and emergency landing. |



## IV. RESTARTING THE ENGINE WITH PROPELLER WINDMILLING

**CAUTION**

Do not engage starter if propeller is windmilling. Engine damage may result.

With a Hoffmann propeller installed the propeller will continue to windmill as long as the airspeed is at least 46 KIAS.

With a Sensenich propeller installed the propeller will continue to windmill as long as the airspeed is at least 60 KIAS.

- |    |                        |                                |
|----|------------------------|--------------------------------|
| 1. | Airspeed ( $V_{IAS}$ ) | 73 kts                         |
| 2. | Mixture                | FULL RICH                      |
| 3. | Fuel Shut-off Valve    | OPEN                           |
| 4. | Ignition Switch        | BOTH                           |
| 5. | Fuel Pump              | ON                             |
| 6. | Fuel Prime             | ON                             |
| 7. | Throttle               | $\frac{3}{4}$ in (2cm) forward |

After successful re-start:

- |     |                                |                |
|-----|--------------------------------|----------------|
| 8.  | Oil Pressure                   | check          |
| 9.  | Oil Temperature                | check          |
| 10. | Fuel Prime                     | OFF            |
| 11. | Electrically Powered Equipment | ON if required |

## V. RESTARTING THE ENGINE WITH PROPELLER AT FULL STOP

- |    |                                |                       |
|----|--------------------------------|-----------------------|
| 1. | Airspeed                       | 73 kts.               |
| 2. | Electrically Powered Equipment | OFF                   |
| 3. | GEN/BAT Master Switch          | ON                    |
| 4. | Mixture                        | FULL RICH             |
| 5. | Fuel shut off valve            | OPEN                  |
| 6. | Fuel Pump                      | ON                    |
| 7. | Fuel Prime                     | ON                    |
| 8. | Throttle                       | 3/4 in (2 cm) forward |
| 9. | Ignition Switch                | START                 |

### NOTE

The engine may also be re-started by increasing the airspeed by pushing the airplane into a descent. A loss of 1000 ft/300 m altitude must be taken into account.

An airspeed of 120 KIAS is required to restart the engine if a Hoffmann propeller is installed

An airspeed of 137 KIAS is required to restart the engine if a Sensenich propeller is installed

After successful re-start:

- |     |                                |                |
|-----|--------------------------------|----------------|
| 8.  | Oil Pressure                   | check          |
| 9.  | Oil Temperature                | check          |
| 10. | Fuel Prime                     | OFF            |
| 11. | Electrically Powered Equipment | ON if required |

### 3.3.2. Gliding

- |    |                               |         |
|----|-------------------------------|---------|
| 1. | Wing Flaps                    | CRUISE  |
| 2. | Airspeed at 1653 lbs (750 kg) | 73 KIAS |
| 3. | Glide Ratio 11:1              |         |
- Example: For every 1000 feet of altitude the aircraft can move forward 11,000 feet or 1.8 NM (3.4 km).

### 3.3.3. Emergency Landing

#### (a) Emergency Landing with Engine off

- |     |                                  |   |
|-----|----------------------------------|---|
| 1.  | Airspeed (Flaps in T/O position) | 58 KIAS   |
| 2.  | Airspeed (Flaps in LDG position) | 52 KIAS   |
| 3.  | Airspeed (Flaps CRUISE)          | 62 KIAS   |
| 4.  | Fuel Shut-off Valve              | CLOSED  |
| 5.  | Mixture                          | IDLE CUTOFF   |
| 6.  | Ignition Switch                  | OFF   |
| 7.  | Safety Belts                     | secured   |
| 8.  | Radio                            | Transmit, 121.5 Mhz, giving location and intentions |
| 9.  | Flaps                            | as required   |
| 10. | GEN/BAT Master Switch            | OFF   |
| 11. | After Touch - Down               | Apply brakes  |

#### (b) Precautionary Landing with Engine Power Available

<b>NOTE</b>
-------------

A precautionary landing would be required if continuing the flight would endanger the aircraft or its occupants. Circumstances, including mechanical defects, low fuel quantity or deteriorating weather conditions could require a precautionary landing.

- |    |  |             |
|----|--|-------------|
| 1. | Search for a suitable place to land. Special attention must be given to wind direction and obstacles in the approach path. |             |
| 2. | Safety Belts   | secured     |
| 3. | Initiate Descent   |             |
| 4. | Mixture  | FULL RICH   |
| 5. | Throttle   | as required |
| 6. | Trim   | as required |
| 7. | Wing Flaps<br>(observe permissible speed)  | as required |

- 8. Over fly selected landing area (not below 500 ft / 150 m above ground) to confirm suitability and that approach route is free of obstacles.
- 9. Climb up to pattern altitude.
- 10. Low pass over flight at a safe altitude to observe any possible obstacles, such as cables, fences, ditches.
- 11. Climb up to pattern altitude.
- 12. Radio Transmit, giving location and intentions
- 13. Final Approach FULL RICH  
 Mixture as required  
 Throttle ON  
 Fuel Pump LDG  
 Wing Flaps 52 KIAS  
 Airspeed
- 14. Touch-down is to be made with minimum airspeed, nose wheel should be kept above ground as long as possible
- 15. After Touch-down: as required  
 Brake CLOSED  
 Fuel Shut-off Valve IDLE CUT-OFF  
 Mixture OFF  
 Ignition Switch OFF  
 GEN/BAT Master Switch

**NOTE**

If no suitable level landing area can be found, an up-hill landing should be performed, if possible.

### 3.3.4. Fire

#### (a) Engine Fire during Engine-Start-Up on the Ground

- |    |                               |             |
|----|-------------------------------|-------------|
| 1. | Fuel Shut-off Valve           | CLOSED      |
| 2. | Cabin Heat                    | CLOSED      |
| 3. | Mixture                       | IDLE CUTOFF |
| 4. | GEN/BAT Master Switch         | OFF         |
| 5. | Ignition Switch               | OFF         |
| 6. | Evacuate Airplane immediately |             |

#### (b) Engine Fire during Flight

- |    |                     |         |
|----|---------------------|---------|
| 1. | Fuel Shut-off Valve | CLOSED  |
| 2. | Cabin Heat          | CLOSED  |
| 3. | Airspeed            | 73 KIAS |

### NOTE

Airspeed is for best glide with flaps in CRUISE position. If a suitable landing area is available and can be safely reached airspeed can be increased in an attempt to extinguish the fire. Do not exceed airspeeds given for structural limitations.

- |    |  |     |
|----|--|-----|
| 4. | Fuel Pump  | OFF |
| 5. | Perform emergency landing with engine off according to paragraph 3.3.3 |     |

#### (c) Electrical Fire including Smoke during Flight

- |    |                       |  |
|----|-----------------------|--|
| 1. | GEN/BAT Master Switch | OFF                                      |
| 2. | Cabin Air             | OPEN                                     |
| 3. | Fire Extinguisher     | use only if smoke development continues. |

### CAUTION

If fire extinguisher is used, the cabin must be ventilated.

In case the fire is extinguished and electric power is required for continuation of the flight:

- |    |                                |     |
|----|--------------------------------|-----|
| 4. | Avionics Master Switch         | OFF |
| 5. | Electrically Powered Equipment | OFF |

<b>NOTE</b>
-------------

Restore electrical power systematically allowing time to monitor the system voltmeter and amp meter between the reconnection of loads. Watch carefully for smoke.

- |     |                           |                                      |
|-----|---------------------------|--------------------------------------|
| 6.  | Circuit Breakers          | Pull all circuit breakers.           |
| 7.  | Circuit Breakers          | Push BATTERY                         |
| 8.  | GEN/BAT Master Switch     | ON BAT ½ only                        |
| 9.  | Circuit Breakers          | Push GEN and GEN CONTROL             |
| 10. | GEN/BAT Master Switch     | ON                                   |
| 11. | Circuit Breakers          | Push AVIONICS and AVIONICS MASTER    |
| 12. | Avionics Master Switch    | ON                                   |
| 13. | Circuit Breakers          | Push to activate systems as required |
| 14. | Radio                     | ON                                   |
| 15. | Land as soon as possible. |                                      |

**(d) Electrical Fire including Smoke on the Ground**

- |    |                       |     |
|----|-----------------------|-----|
| 1. | GEN/BAT Master Switch | OFF |
|----|-----------------------|-----|

If engine running:

- |    |                     |                       |
|----|---------------------|-----------------------|
| 2. | Throttle            | IDLE                  |
| 3. | Mixture             | IDLE CUTOFF           |
| 4. | Fuel Shut-off Valve | CLOSED                |
| 5. | Ignition Switch     | OFF                   |
| 6. | Canopy              | open                  |
| 7. | Fire Extinguisher   | discharge as required |

**(e) Cabin Fire during Flight**

- |    |                          |                       |
|----|--------------------------|-----------------------|
| 1. | GEN/BAT Master Switch    | OFF                   |
| 2. | Cabin Air                | OPEN                  |
| 3. | Cabin Heat               | CLOSED                |
| 4. | Fire Extinguisher        | discharge as required |
| 5. | Land as soon as possible |                       |

<b>CAUTION</b>
----------------

If fire extinguisher is used, the cabin must be ventilated.

### 3.3.5. Icing

#### Unintentional Flight into Icing Area

1. Leave icing area (through change of altitude or change of flight direction to reach area with higher outside air temp.).
2. Continue to move control surfaces to maintain their moveability.
3. Alternate Air ON
4. Increase RPM to avoid icing of propeller blades (observe maximum RPM)
5. Cabin Heat ON  
DEFROST

**CAUTION**

In case of icing on the leading edge of the wing, the stall speed will increase.

**CAUTION**

In case of icing on wing leading edge, erroneous indicating of the airspeed, altimeter, rate of climb and stall warning should be expected.

### 3.3.6. Recovery from Unintentional Spin

1. Throttle IDLE
2. Rudder fully applied opposite to direction of spin
3. Control Stick ease forward
4. Rudder neutral, after rotation has stopped
5. Wing Flaps CRUISE
6. Elevator pull cautiously

Bring airplane from descent into level flight position. Do not exceed maximum permissible speed ( $v_{NE}$ )

### 3.3.7. Landing with Defective Tire on Main Landing Gear

1. Final approach with wing flaps in landing position.
2. Land airplane on the side of runway opposite to the side with the defective tire to compensate for change in direction which is to be expected during final rolling.
3. Land with wing slightly tipped in the direction of the non-defective tire. To increase the maneuverability during rolling, the nose-wheel should be brought to the ground as soon as possible after touch-down.
4. To ease the load on the defective tire, the aileron should be fully applied in the direction of the non-defective tire.

### 3.3.8. [Intentionally left blank]



### 3.3.9. Electrical Power Failure

#### a) Total Electrical Power Failure

- |    |                         |                                  |
|----|-------------------------|----------------------------------|
| 1. | Battery Circuit Breaker | If tripped, reset                |
| 2. | GEN/BAT Master Switch   | check ON                         |
| 3. | Master Switch           | OFF if power not restored        |
| 4. | If Unsuccessful         | Land at nearest suitable airport |

#### b) Generator Failure

GEN. Annunciator Illuminated

- |    |   |  |
|----|---|--|
| 1. | GEN/BAT Master Switch                   | Cycle Generator Master Switch OFF - ON   |
| 2. | Generator Circuit Breaker               | If tripped, reset  |
| 3. | Generator CONTROL Circuit Breaker       | If tripped, reset  |
| 4. | If Generator can not be brought on-line | Switch OFF all non-flight essential electrical consumers. Monitor Ammeter and Voltmeter. Land at nearest suitable airport. |

<b>NOTE</b>
-------------

There is 30 minutes of battery power at a discharge load of 20 amperes when the battery is fully charged and properly maintained.

#### c) Low Voltage Indication (needle in yellow Arc)

I. LOW VOLTAGE INDICATION (NEEDLE IN YELLOW ARC) WHILE AIRPLANE ON GROUND

- |    |   |   |
|----|---|---|
| 1. | Engine RPM  | Increase RPM until needle is in the Green Arc. This should occur before exceeding 1100 RPM. |
| 2. | Non-flight essential electrical consumers   | Switch OFF consumers until needle is in the Green Arc.                                      |
| 3. | If needle remains in the yellow arc and the ammeter is indicating to the left of center (discharge) | Discontinue any planned flight activity   |



### 3.3.10. Flap System Failure

#### Flap Position Indicator Failure

- visual check of the flap position
- select airspeed within the range of the white arc marked on the airspeed indicator
- check all positions of the flap toggle switch (flap stops are fail-safe)
- modify approach and landing as follows:
  - only CRUISE available:
    - raise approach speed by 10 kts
    - throttle as required
    - flat approach angle
  - only T/O available:
    - normal approach speed
    - throttle as required
    - flat approach angle
  - only LDG available:
    - normal landing

### 3.3.11. Starter Relay Failure

Starter does not disengage after starting the engine (start light remains illuminated).

- |    |                 |             |
|----|-----------------|-------------|
| 1. | Throttle        | IDLE        |
| 2. | Mixture         | IDLE CUTOFF |
| 3. | Ignition Switch | OFF         |
- discontinue any planned flight.  
Maintenance action is required

### 3.3.12 Avionics System Failure

Total Avionics Failure:

1. Check Avionics Master Circuit Breaker  
If popped, press and monitor status, If it pops again, land at nearest suitable airport
2. Check Avionics Master Switch  
Toggle avionics master switch, if avionics system remains off-line, pull avionics master control circuit breaker. Land at nearest suitable airport if operation is not restored

Radio System Operative, no reception:

1. Microphone Key  
check for stuck Microphone Key on transceiver display
2. Headphones  
check, deactivate SQUELCH for a few moments, if SQUELCH not heard, check headset connection

Radio System Operative, transmitting not possible:

1. Selected Frequency  
check if correct
2. Microphone  
check, if available use different one (headset)

Problem cannot be resolved: switch transponder (if available) to "COMM FAILURE" code if required by the situation and permitted by applicable national regulations.

### 3.3.13 Trim System Failure

Stuck Trim:

- |    |                 |  |
|----|-----------------|--|
| 1. | Circuit breaker | check, press if breaker is tripped                       |
| 2. | Rocker switch   | depress in both directions, wait<br>5 minutes, try again |

<b>NOTE</b>
-------------

Full range of travel is available for elevator, but expect higher forces on control stick.

3. Land at nearest suitable airport

Runaway of Trim:

- |    |                            |   |
|----|----------------------------|---|
| 1. | Control Stick              | Grip stick and maintain control of airplane |
| 2. | Trim motor circuit breaker | Pull circuit breaker                        |
| 3. | Rocker Switch              | Check if depressed                          |

If reason for runaway condition is obvious and has been resolved, push in (engage) circuit breaker.

<b>NOTE</b>
-------------

Full travel of the elevator trim system will take approximately 10 seconds.

### 3.3.14 Instrument Panel Lighting Failure

1. Rocker Switch, map light                      ON
2. Rocker Switch, I-panel lighting              Cycle Rocker Switch OFF - ON
3. Dimming Control                                Turn fully clockwise
4. Internal Lighting Circuit Breaker.            If tripped, reset
5. If NOT Successful                                Use Flashlight

Expect electrical power failure.              Ref. 3.3.9

## CHAPTER 4

# NORMAL OPERATING PROCEDURES

<b>4.1.</b>	<b>INTRODUCTION</b>	<b>4- 2</b>
<b>4.2.</b>	<b>AIRSPEEDS FOR NORMAL FLIGHT OPERATION</b>	<b>4- 2</b>
<b>4.3.</b>	<b>STRUCTURAL TEMPERATURE INDICATOR</b>	<b>4- 3</b>
<b>4.4.</b>	<b>NORMAL OPERATION CHECKLIST</b>	<b>4- 5</b>
<b>4.4.1.</b>	<b>Preflight Inspection</b>	
	<b>I. In-Cabin Check</b>	<b>4- 5</b>
	<b>II. Walk-Around Check</b>	<b>4- 6</b>
<b>4.4.2.</b>	<b>Before Starting Engine</b>	<b>4- 9</b>
<b>4.4.3.</b>	<b>Starting Engine</b>	<b>4-10</b>
<b>4.4.4.</b>	<b>Before Taxiing</b>	<b>4-13</b>
<b>4.4.5.</b>	<b>Taxiing</b>	<b>4-13</b>
<b>4.4.6.</b>	<b>Before Take-off (Engine Run-up)</b>	<b>4-14</b>
<b>4.4.7.</b>	<b>Take-off</b>	<b>4-15</b>
<b>4.4.8.</b>	<b>Climb</b>	<b>4-16</b>
<b>4.4.9.</b>	<b>Cruise</b>	<b>4-16</b>
<b>4.4.10.</b>	<b>Descent</b>	<b>4-17</b>
<b>4.4.11.</b>	<b>Landing Approach</b>	<b>4-17</b>
<b>4.4.12.</b>	<b>Balked Landing</b>	<b>4-18</b>
<b>4.4.13.</b>	<b>After Landing</b>	<b>4-18</b>
<b>4.4.14.</b>	<b>Engine Shut-down</b>	<b>4-18</b>
<b>4.4.15.</b>	<b>Flight in Rain</b>	<b>4-18</b>
<b>4.4.16.</b>	<b>Spinning</b>	<b>4-19</b>
<b>4.4.17.</b>	<b>Idle Power Operations</b>	<b>4-20</b>

## 4.1. INTRODUCTION

Chapter 4 provides checklist and amplified procedures for the normal operation.

## 4.2. AIRSPEEDS FOR NORMAL FLIGHT OPERATION

Unless stated otherwise, the following table contains the applicable airspeeds for maximum take-off and landing weight. The airspeeds may also be used for lower flight weights.

TAKE-OFF	KIAS
Climb Speed during normal take-off for 50 ft (15 m) obstacle	58
Best Rate-of-Climb speed at sea level $v_y$ . Wing Flaps CRUISE	75
Best Angle-of-Climb speed at sea level $v_x$ . Wing Flaps CRUISE (Hoffmann prop.)	66
Best Angle-of-Climb speed at sea level $v_x$ . Wing Flaps CRUISE (Sensenich prop.)	60
Best Rate-of-Climb speed at sea level $v_y$ . Wing Flaps T/O	68
Best Angle-of-Climb speed at sea level $v_x$ . Wing Flaps T/O (Hoffmann prop.)	62
Best Angle-of-Climb speed at sea level $v_x$ . Wing Flaps T/O (Sensenich prop.)	57

LANDING	KIAS
Approach speed for normal landing. Wing Flaps LDG	52
Balked landing climb speed. Wing Flaps LDG	52
Maximum demonstrated crosswind speed during take-off and landing	20

CRUISE	KIAS
Maximum permissible speed in rough air $v_{NO}$	118
Maximum permissible speed with full control surface deflections $v_A$	106
Maximum permissible speed with Wing Flaps in T/O Position ( $v_{FE T/O}$ )	100
Maximum permissible speed with Wing Flaps in LDG Position ( $v_{FE LDG}$ )	78



### 4.3 STRUCTURAL TEMPERATURE INDICATOR

A structural temperature indicator, installed on the spar bridge, indicates when the structural temperature limitation is exceeded (ref. section 2.17). The indicator need only be checked if the OAT exceeds 38° C (100° F).

The indicator is accessed by lifting the flap between the two seat-back cushions. The indicator is visible through the cut out in the seat shell backs (ref. fig. 2).

At temperatures below the 55° C (131° F) limit, the indicator appears all red with a faint indication of “55” (° C). At temperatures exceeding the 55° C (131° F) limit, the indicator displays a clearly contrasting red “55” (° C) on a black background (ref. fig.1).

**NOTE**

At temperatures approaching the limit, the background will progressively darken prior to turning black; this indicates acceptable temperatures.

**NOTE**

Aircraft with other than white undersides have an additional structural temperature indicator installed adjacent to the fuel drains.

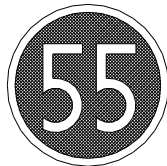

Red “55” on black background indicates that structural temperature limit is exceeded. Flight is prohibited.

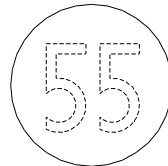

All red indicates that structural temperature is below limit. Flight is permitted.

Figure 1

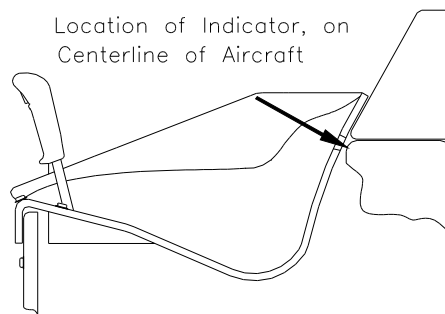
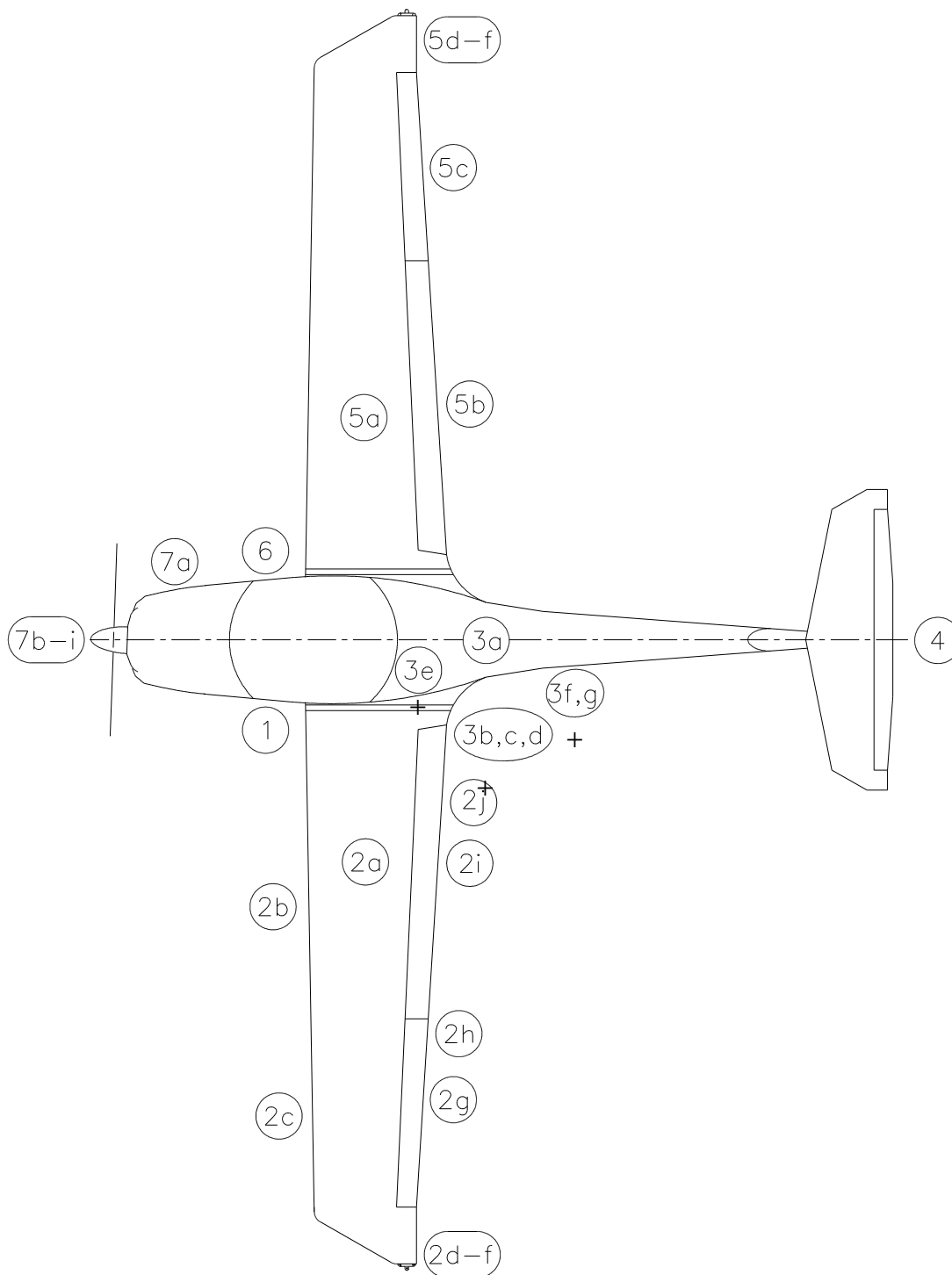

Figure 2

[INTENTIONALLY LEFT BLANK]



II. Walk Around Check and Visual Inspection



<b>CAUTION</b>
----------------

Visually inspect for the following conditions: Defects, contamination, cracks, delaminations, excessive play, insecure or improper mounting and general condition.

Additionally, check the control surfaces for freedom of movement.

<b>CAUTION</b>
----------------

Set PARKING brake prior to removing wheel chocks

### 1. Left Main Landing Gear

- |                                     |                   |
|-------------------------------------|-------------------|
| a) Landing Gear Strut               | visual inspection |
| b) Wheel Fairing                    | visual inspection |
| c) Tire Pressure (33 psi / 2.3 bar) | check             |
| d) Tire, Wheel, Brake               | visual inspection |
| e) Wheel Chocks                     | remove            |

### 2. Left Wing

- |   |                         |
|---|-------------------------|
| a) Entire Wing                          | visual inspection       |
| b) Stall Warning                        | check (suck on opening) |
| c) Pitot-Static Probe                   | clean, holes open       |
| d) Tie down                             | remove                  |
| e) Taxi and Landing Lights              | visual inspection       |
| f) Wing Tip, Position Lights and Strobe | visual inspection       |
| g) Aileron Balancing Weight             | visual inspection       |
| h) Aileron including Inspection Panel   | visual inspection       |
| i) Wing Flap including Inspection Panel | visual inspection       |

### 3. Fuselage

- |  |   |
|--|---|
| a) Skin  | visual inspection   |
| b) Fuel Tank Vent  | check   |
| c) Fuel Drains   | drain water   |
| d) Structural Temperature Indicator<br>(for aircraft with other than white undersides) | check that structural temperature does<br>not exceed 55 °C (131 °F) |
| e) Maintenance Fuel Drains   | no leaks  |
| f) Fuel Quantity   | visual inspection (use fuel pipette)                                |
| g) Antennas  | visual inspection   |

**4. Empennage**

- |                                     |                   |
|-------------------------------------|-------------------|
| a) Stabilizers and Control Surfaces | visual inspection |
| b) Tie down                         | remove            |
| c) Fixed Tab on Rudder              | visual inspection |

**5. Right Wing**

- |   |                   |
|---|-------------------|
| a) Entire Wing                          | visual inspection |
| b) Wing Flap including Inspection Panel | visual inspection |
| c) Aileron including Inspection Panel   | visual inspection |
| d) Aileron Balancing Weight             | visual inspection |
| e) Wing Tip, Position Lights and Strobe | visual inspection |
| f) Tie down                             | remove            |

**6. Right Main Landing Gear**

- |                                     |                   |
|-------------------------------------|-------------------|
| a) Landing Gear Strut               | visual inspection |
| b) Wheel Fairing                    | visual inspection |
| c) Tire Pressure (33 psi / 2.3 bar) | check             |
| d) Tire, Wheel, Brake               | visual inspection |
| e) Wheel Chocks                     | remove            |

**7. Nose**

- |                                     |   |
|-------------------------------------|---|
| a) Oil                              | check level by using dip-stick. Max level is 6 US quarts Min level is 4 US quarts |
| b) Cowling                          | visual inspection   |
| c) Air Intakes                      | clear   |
| d) Propeller                        | visual inspection, Ground Clearance; minimum: approx. 25 cm (10 in).              |
| e) Propeller Blades                 | check for damage  |
| f) Spinner                          | visual inspection   |
| g) Nose Gear                        | visual inspection, towbar removed   |
| h) Wheel Fairing                    | visual inspection   |
| i) Tire Pressure (26 psi / 1.8 bar) | check   |
| j) Tire and Wheel                   | visual inspection   |
| k) Wheel Chocks                     | remove  |

**4.4.2. Before Starting Engine**

1.	Preflight Inspection	performed
2.	Pedals	adjust, lock
3.	Passenger Briefing	performed
4.	Safety Belts	fasten
5.	Parking Brake	set
6.	Flight Controls	free
7.	Fuel Shut-off Valve	OPEN
8.	Mixture	FULL RICH
9.	Throttle	IDLE
10.	Friction Device of Throttle Quadrant	adjust
11.	Avionics Master Switch	OFF
12.	GEN/BAT Master Switch	ON
13.	Generator Warning Light	illuminated
14.	Exterior Lights	as required
15.	Instrument Panel Lighting	as required
16.	Canopy	Close and Secure
17.	Canopy Unlock Warning Light	OFF

### 4.4.3. Starting Engine

#### (a) Starting Engine Cold

#### NOTE

It is recommended that the engine be preheated if it has been cold soaked for 2 hours or more at temperatures of -4°C (25°F) or less.

- |    |                |           |
|----|----------------|-----------|
| 1. | Throttle       | IDLE      |
| 2. | Mixture        | FULL RICH |
| 3. | Toe Brakes     | hold      |
| 4. | Propeller Area | clear     |

#### WARNING

Ensure that propeller area is clear!

#### CAUTION

Do not engage starter if propeller is moving. Serious engine damage can result

#### NOTE

Steps 5, 6, 7, 8 and 9 are to be performed without delay between steps.

#### NOTE

Colder ambient temperatures require longer priming

- |     |                       |   |
|-----|-----------------------|---|
| 5.  | Fuel Pump             | ON  |
| 6.  | Fuel Prime            | ON  |
| 7.  | Throttle              | FULL for prime<br>(prime for 3 seconds minimum before starting)   |
| 8.  | Throttle              | Full IDLE to ¼ inch OPEN as required  |
| 9.  | Ignition Switch       | START, hold until engine starts or for 10 seconds maximum<br>(if engine does not start, release ignition key, then push throttle to full power for 3 seconds minimum for more priming, then repeat from Step 8) |
| 10. | Starter Warning Light | illuminated while ignition is in START position   |



<b>NOTE</b>
-------------

Activate starter for maximum of 30 seconds only,  
followed by a cooling period of 3-5 minutes

- |     |          |                 |
|-----|----------|-----------------|
| 11. | Throttle | 800 to 1000 RPM |
|-----|----------|-----------------|

<b>CAUTION</b>
----------------

Do not operate engine above 1000 RPM until  
an oil temperature indication is registered.

- |     |                    |       |
|-----|--------------------|-------|
| 12. | Fuel Prime         | OFF   |
| 13. | Engine Instruments | check |

<b>NOTE</b>
-------------

Excessive priming can result in a flooded engine. To clear a flooded engine, turn off fuel pump and fuel prime, open throttle ½ - 1 inch and engage starter. The engine should start for a short period and then stop. Excess fuel has now been cleared and engine start from item 1 can be performed.

<b>CAUTION</b>
----------------

If oil pressure is below 10 psi, shut down engine immediately (maximum 30 seconds delay).

<b>NOTE</b>
-------------

Oil Pressure may advance above the green arc until Oil Temp. reaches normal operating temperatures.

Regulate warm up RPM to maintain pressure below 100 psi limit. At ambient temperatures below 32°F (0°C) **DO NOT** apply full power if oil pressure is above 70 psi.

- |     |                       |           |
|-----|-----------------------|-----------|
| 14. | Starter Warning Light | check OFF |
|-----|-----------------------|-----------|

**(b) Starting Engine Warm**

- |    |                |           |
|----|----------------|-----------|
| 1. | Throttle       | IDLE      |
| 2. | Mixture        | FULL RICH |
| 3. | Toe Brakes     | hold      |
| 4. | Propeller Area | clear     |

<b>WARNING</b>
----------------

Ensure that propeller area is clear!

<b>CAUTION</b>
----------------

Do not engage starter if the propeller is moving. Serious damage can result.

<b>NOTE</b>
-------------

Steps 5, 6, 7, 8 and 9 are to be performed without delay between steps.

- |     |                       |   |
|-----|-----------------------|---|
| 5.  | Fuel Pump             | ON  |
| 6.  | Fuel Prime            | ON  |
| 7.  | Throttle              | Full for prime, 1 to 3 seconds before starting  |
| 8.  | Throttle              | ½ - 1 inch OPEN (approximately)   |
| 9.  | Ignition Switch       | START, hold until engine starts or for 10 seconds maximum (repeat from Step 7 if engine does not start) |
| 10. | Starter Warning Light | illuminated while ignition is in START position   |

<b>NOTE</b>
-------------

Activate starter for maximum of 30 seconds only, followed by a cooling period of 3-5 minutes.

- |     |                    |                 |
|-----|--------------------|-----------------|
| 11. | Throttle           | 800 to 1000 RPM |
| 12. | Fuel Prime         | OFF             |
| 13. | Engine Instruments | check           |

<b>NOTE</b>
-------------

Excessive priming can result in a flooded engine. To clear a flooded engine, turn off fuel pump and fuel prime, open throttle ½ - 1 inch and engage starter. The engine should start for a short period and then stop. Excess fuel has now been cleared and engine start from item 1 can be performed.

<b>CAUTION</b>
----------------

If oil pressure is below 10 psi, shut down engine immediately (maximum 30 seconds delay).

<b>NOTE</b>
-------------

Oil Pressure may advance above the green arc until Oil Temp. reaches normal operating temperatures. Regulate warm up RPM to maintain pressure below 100 psi limit. At ambient temperatures below 32°F (0°C) **DO NOT** apply full power if oil pressure is above 70 psi.

- |     |                       |           |
|-----|-----------------------|-----------|
| 14. | Starter Warning Light | CHECK OFF |
|-----|-----------------------|-----------|

#### 4.4.4. Before Taxiing

- |    |  |   |
|----|--|---|
| 1. | Avionics Master Switch                                 | ON  |
| 2. | Flight Instruments and Avionics                        | set   |
| 3. | Engine Gauges  | check   |
| 4. | Voltmeter  | check, ensure needle is in the green arc. Increase RPM to achieve or turn OFF non-flight essential electrical consumers |
| 5. | Warning Lights, Gen, Canopy, Start, EPU (if installed) | push to test  |
| 6. | Fuel Prime   | check OFF   |
| 7. | Fuel Pump  | check ON  |
| 8. | Parking Brake  | release   |

### CAUTION

Warm-up engine to a minimum Oil Temperature of 75° F at 1000 to 1200 RPM (also possible during taxi).  
Do not operate engine above 1000 RPM until an oil temperature indication is registered.

#### 4.4.5. Taxiing

- |    |                                 |             |
|----|---------------------------------|-------------|
| 1. | Brake                           | check       |
| 2. | Mixture                         | FULL RICH   |
| 3. | Throttle                        | As required |
| 4. | Direction Control               | check       |
| 5. | Flight Instruments and Avionics | check       |
| 6. | Compass                         | check       |

### CAUTION

At high engine RPM the propeller may be damaged by loose sand, gravel or water.

#### 4.4.6. Before Take-off (Engine Run-up)

<b>NOTE</b>
-------------

For OAT's less than -5° F (-20° C) turn cabin heat on for at least 10 minutes prior to take-off.

- |     |                             |  |
|-----|-----------------------------|--|
| 1.  | Brakes                      | apply  |
| 2.  | Safety Belts                | fastened   |
| 3.  | Canopy                      | closed and locked  |
| 4.  | Canopy Unlock Warning Light | OFF  |
| 5.  | Fuel Pressure               | check  |
| 6.  | Fuel Shut-off Valve         | check OPEN   |
| 7.  | Fuel Quantity Indicator     | check  |
| 8.  | Fuel Prime                  | check OFF  |
| 9.  | Fuel Pump                   | check ON   |
| 10. | Trim                        | NEUTRAL  |
| 11. | Flight Controls             | free   |
| 12. | Oil Temp.                   | 75° minimum  |
| 13. | Oil Pressure                | 30-60 psi  |
| 14. | Mixture                     | FULL RICH  |
| 15. | Throttle                    | 1700 RPM   |
| 16. | Magneto Check               | Cycle L - BOTH - R - BOTH<br>(RPM drop: 25-150 RPM)<br>(Max. RPM difference (L/R): 50 RPM)                                 |
| 17. | Mixture                     | check  |
| 18. | Alt. Load                   | check  |
| 19. | Vacuum Gauge                | within green range   |
| 20. | Throttle                    | IDLE<br>(975 RPM Minimum, for aircraft with altitude compensating fuel system )  |
| 21. | Mixture                     | Move slowly toward lean cut off<br>(RPM increase)<br>(50 RPM Minimum, for aircraft with altitude compensating fuel system) |
| 22. | Mixture                     | FULL RICH  |
| 23. | Circuit Breakers            | check pressed IN   |
| 24. | Wing Flaps                  | T/O  |
| 25. | Parking Brake               | release  |

#### 4.4.7. Take-off

- |                                       |                      |
|---------------------------------------|----------------------|
| 1. Fuel Prime                         | check OFF            |
| 2. Fuel Pump                          | check ON             |
| 3. Mixture                            | check FULL RICH      |
| 4. GEN/BAT Master Switch              | check ON             |
| 5. Ignition Switch                    | check BOTH           |
| 6. Wing Flaps                         | check T/O            |
| 7. Trim                               | NEUTRAL              |
| 8. Throttle                           | FULL                 |
| Check RPM                             | min 2000 RPM         |
| 9. Elevator - at beginning of rolling | NEUTRAL              |
| 10. Directional Control               | maintain with rudder |

<b>NOTE</b>
-------------

In crosswind conditions, directional control can be enhanced by using the single wheel brakes. Note that using the brakes for directional control increases the take-off roll distance.

- |  |         |
|--|---------|
| 11. Rotate                               | 44 KIAS |
| 12. Climb Speed to clear 50 ft. obstacle | 58 KIAS |

<b>CAUTION</b>
----------------

For the shortest possible take-off distance to clear a 15 m (50 ft) obstacle:

- |                                      |         |
|--------------------------------------|---------|
| Lift-off Speed                       | 52 KIAS |
| Climb Speed to clear 50 ft. obstacle | 58 KIAS |

#### 4.4.8. Climb

- |    |         |           |
|----|---------|-----------|
| 1. | Mixture | FULL RICH |
|----|---------|-----------|

<b>NOTE</b>
-------------

For aircraft without the altitude compensating fuel pump, at full throttle settings with power less than 75%, it is necessary to lean the engine with the mixture control. It should be noted that with the engine set to full throttle, it can produce less than 75% power, depending on pressure altitude. Refer to the performance section 5.3.2 to determine the engine performance as a function of altitude and temperature. Expect engines without altitude compensating fuel pump to require leaning at full throttle above 5000 ft pressure altitude.

- |    |                         |                    |
|----|-------------------------|--------------------|
| 2. | Throttle                | FULL               |
| 3. | Engine Gauges           | within green range |
| 4. | Wing Flaps (400 ft AGL) | CRUISE             |
| 5. | Airspeed                | 75 KIAS            |
| 6. | Trim                    | adjust             |

#### 4.4.9. Cruise

- |    |               |  |
|----|---------------|--|
| 1. | Fuel Pump     | OFF  |
| 2. | Throttle      | as required  |
| 3. | Mixture       | lean to 25°F rich of peak EGT. <u>DO</u><br><u>NOT</u> lean by EGT above 75% power |
| 4. | Wing Flaps    | CRUISE   |
| 5. | Trim          | as required  |
| 6. | Engine Gauges | check  |

#### 4.4.10. Descent

- |    |                                 |             |
|----|---------------------------------|-------------|
| 1. | Flight Instruments and Avionics | adjust      |
| 2. | Fuel Pump                       | ON          |
| 3. | Mixture                         | FULL RICH   |
| 4. | Throttle                        | as required |

### CAUTION

CHT not below 300°F for more than 5 minutes. 240°F Min.

### NOTE

To achieve a fast descent:

Throttle	IDLE
Wing Flaps	CRUISE
Airspeed	118 KIAS

#### 4.4.11. Landing Approach

- |     |                       |              |
|-----|-----------------------|--------------|
| 1.  | Seat Belts            | fastened     |
| 2.  | Lights                | as required  |
| 3.  | GEN/BAT Master Switch | check ON     |
| 4.  | Ignition Switch       | check BOTH   |
| 5.  | Fuel Pump             | check ON     |
| 6.  | Mixture               | FULL RICH    |
| 7.  | Throttle              | as required  |
| 8.  | Airspeed              | max. 78 KIAS |
| 9.  | Wing Flaps            | T/O          |
| 10. | Trim                  | as required  |
| 11. | Wing Flaps            | LDG          |
| 12. | Approach Speed        | 52 KIAS      |

### CAUTION

For strong headwind, crosswind, danger of wind-shear or turbulence, a higher approach speed should be selected.

**4.4.12. Balked Landing**

- |    |            |           |
|----|------------|-----------|
| 1. | Throttle   | FULL      |
| 2. | Mixture    | FULL RICH |
| 3. | Wing Flaps | T/O       |
| 4. | Airspeed   | 58 KIAS   |

**4.4.13. After Landing**

- |    |                 |             |
|----|-----------------|-------------|
| 1. | Throttle        | as required |
| 2. | Mixture         | FULL RICH   |
| 3. | Wing Flaps      | CRUISE      |
| 4. | Avionics        | as required |
| 5. | Exterior Lights | as required |

**4.4.14. Engine Shut-down**

- |     |                            |   |
|-----|----------------------------|---|
| 1.  | Parking Brake              | set   |
| 2.  | Throttle                   | 1700 RPM  |
| 3.  | Magneto Check              | Cycle L - BOTH - R - BOTH<br>( RPM drop: 25-150 RPM)<br>(Max. RPM difference (L/R): 50 RPM) |
| 4.  | Throttle                   | IDLE  |
| 5.  | Fuel Pump                  | OFF   |
| 6.  | Mixture                    | IDLE CUT-OFF  |
| 7.  | Ignition Switch            | OFF   |
| 8.  | ELT                        | Check (by listening to 121.5 MHZ for<br>signal)   |
| 9.  | Avionics Master Switch     | OFF   |
| 10. | Electric Consumers         | OFF   |
| 11. | GEN/BAT Master Switch      | OFF   |
| 12. | Tie Downs and Wheel Chocks | as required   |

**4.4.15. Flight in Rain**

<b>NOTE</b>
-------------

Flight performance might be reduced, especially for the T/O-distance and the maximum horizontal air speed. The influence on flight characteristics of the airplane is negligible. Flights through heavy rain should be avoided due to the reduced visibility.



#### 4.4.16. Spinning

##### (a) Spin Entry

- |     |                            |  |
|-----|----------------------------|--|
| 1.  | Loose Items                | stowed   |
| 2.  | Seat Belts                 | fastened   |
| 3.  | Altitude and Airspace      | check  |
| 4.  | Fuel Pump                  | ON   |
| 5.  | Wing Flaps                 | CRUISE   |
| 6.  | Mixture                    | FULL RICH  |
| 7.  | Throttle                   | IDLE   |
| 8.  | Entry Speed                | trim to 58 KIAS                                      |
| 9.  | Reduce speed with elevator | speed reduction rate 2-3 kts per second              |
| 10. | When stall warning sounds  | apply simultaneously, full aft stick and full rudder |

### CAUTION

Intentional spinning is only permitted with flaps in CRUISE position.

### CAUTION

Depending on CG and spin entry technique, attempts to enter spins may develop into spiral dives. Monitor the airspeed during the first turn and recover immediately if it increases to 65 KIAS.

### NOTE

Spins with aft CG may oscillate in yaw rate and pitch attitude. This has no effect on recovery procedure or recovery time

##### (b) Recovery from Spinning

- |    |               |  |
|----|---------------|--|
| 1. | Throttle      | IDLE   |
| 2. | Rudder        | fully applied in opposite to direction of spin   |
| 3. | Control Stick | ease stick forward until spinning stops          |
| 4. | Rudder        | neutral, immediately after rotation has stopped. |
| 5. | Wing Flaps    | check CRUISE                                     |
| 6. | Control Stick | ease stick backward cautiously                   |
- Bring airplane from descent into level flight position.  
Do not exceed maximum permissible speed ( $V_{NE}$ )

#### 4.4.17. Idle Power Operations

<b>NOTE</b>
-------------

Turn fuel pump on for all low throttle operations, including taxiing and all flight operations when engine speed could fall below 1400 RPM (eg. stalls, descents, spins, landings, etc.)

- |    |           |           |
|----|-----------|-----------|
| 1. | Fuel Pump | ON        |
| 2. | Mixture   | FULL RICH |
| 3. | Throttle  | IDLE      |

<b>NOTE</b>
-------------

For aircraft with altitude compensating fuel system minimum recommended flight idle is 1400 RPM, during idle power flight conditions and maneuvers.

## CHAPTER 5

# PERFORMANCE

- 5.1. INTRODUCTION .....2
- 5.2. USE OF PERFORMANCE TABLES AND DIAGRAMS.....2
- 5.3. PERFORMANCE TABLE AND DIAGRAMS .....3
  - 5.3.1 Figure 5.1: Airspeed System Calibration .....3
  - 5.3.2. Figure 5.2(a): Cruising Performance .....4
  - 5.3.3. Figure 5.3: Stall Speeds.....6
  - 5.3.4. Figure 5.4: Wind Components .....7
  - 5.3.5 Figure 5.5(a): Take-off Distance.....8
  - 5.3.6. Figure 5.6(a): Climb Performance / Cruising Altitudes.....10
  - 5.3.7. Figure 5.7(a): Climb Performance / Take off.....12
  - 5.3.8 Figure 5.8(a): Cruising Speed (True Airspeed).....14
  - 5.3.9. Figure 5.9(a): Maximum Flight Duration .....16
  - 5.3.10. Figure 5.10(a): Climb Performance / Balked Landing.....18
  - 5.3.11. Landing Distance .....20
- 5.4 Noise Data .....20

## 5.1. INTRODUCTION

This chapter contains the performance data required by the basis of certification. This data which has been approved by Transport Canada is marked 'DOT Approved' in the footer of the page. Where additional performance data has been provided, beyond the basis for certification, it has not been reviewed or approved by Transport Canada.

The performance data contained in the following pages has been prepared to illustrate the performance you may expect from your airplane and to assist you in precise flight planning. The data presented has been derived from test-flights using an airplane and engine in good operating condition. The data is corrected to standard atmospheric conditions (59° F (15° C) and 29.92 in. Hg (1013.25 mbar) at sea level) except where noted.

The performance data do not take into account the expertise of the pilot or the maintenance condition of the airplane. The performance described can be achieved if the indicated procedures are followed and the airplane is maintained in good condition.

## 5.2. USE OF PERFORMANCE TABLES AND DIAGRAMS

The performance data is shown in the form of tables and diagrams to illustrate the influence of different variables. The tables contain sufficiently detailed information to plan flights with precision and safety. Where the performance differs due to the type of propeller that is installed, the table or graph is printed for each propeller and clearly identified.

### 5.3. PERFORMANCE TABLE AND DIAGRAMS

#### 5.3.1 Figure 5.1: **Airspeed System Calibration**

Assumes zero indicator error

<b>Flaps Cruise</b>																	
CIAS	42	50	55	60	65	70	75	80	90	100	110	120	130	140	150	160	164
KCAS	52 V <sub>S1</sub>	58	62	66	70	75	79	83	92	101	110	120	129	138	147	156	159 V <sub>NE</sub>
<b>Flaps T/O</b>																	
CIAS	38	45	50	55	60	65	70	75	80	85	90	95	100	105	---	---	---
KCAS	48 V <sub>S1</sub>	53	57	61	65	69	73	77	81	85	89	93	96	100 V <sub>FE</sub>	---	---	---
<b>Flaps LDG</b>																	
CIAS	34	40	45	50	55	60	65	70	75	82	---	---	---	---	---	---	---
KCAS	44 V <sub>S0</sub>	48	52	55	59	64	68	72	76	81 V <sub>FE</sub>	---	---	---	---	---	---	---

*Example:* CRUISE Flap CIAS = 90 kts therefore KCAS = 92 kts from chart

5.3.2. Figure 5.2(a): Cruising Performance

HOFFMANN PROPELLER HO-14HM-175-157

Maximum RPM is 2800

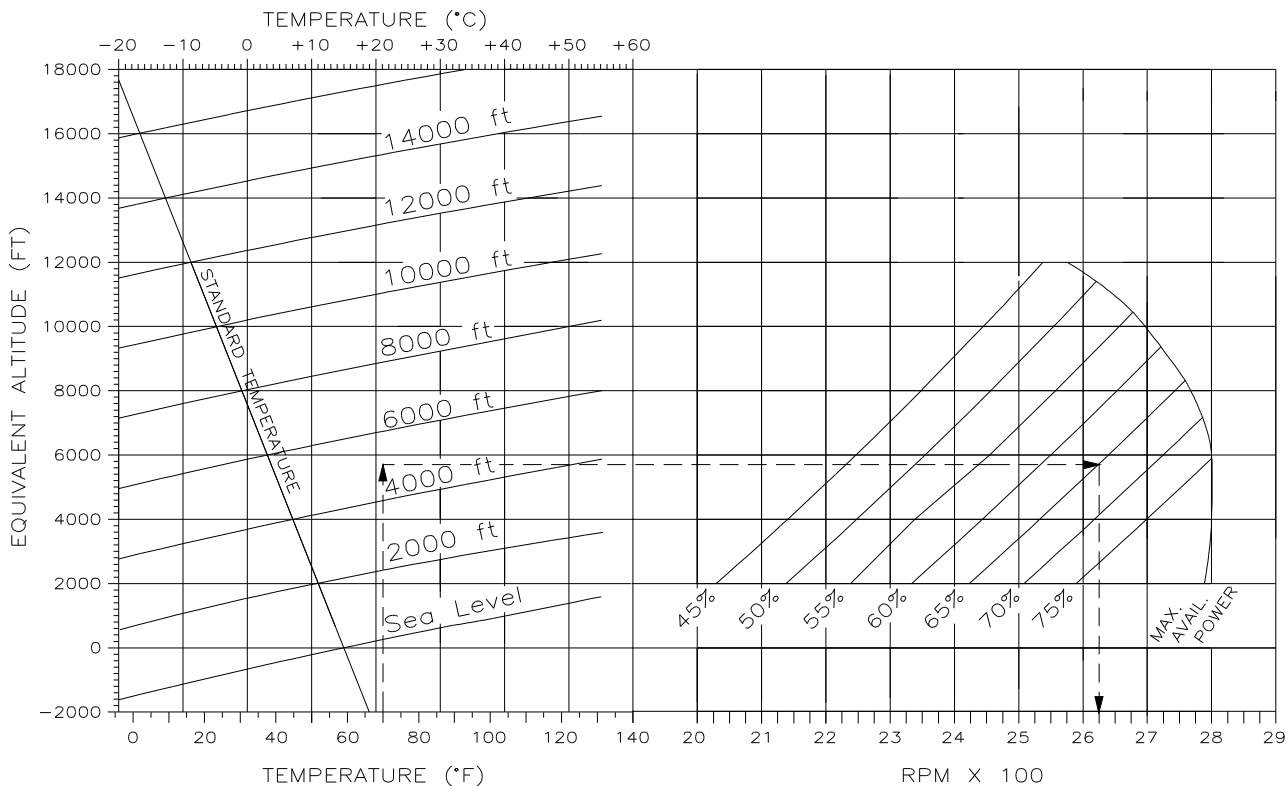

<i>Example:</i>	OAT:	70° F
	Pressure Altitude:	5000 ft
	Desired Power setting:	65%
<i>Result:</i>	Set RPM:	2625

**Figure 5.2(b): Cruising Performance**

**SENENICH PROPELLER**

**W69EK7-63, W69EK7-63G and W69EK-63**

Maximum RPM is 2800

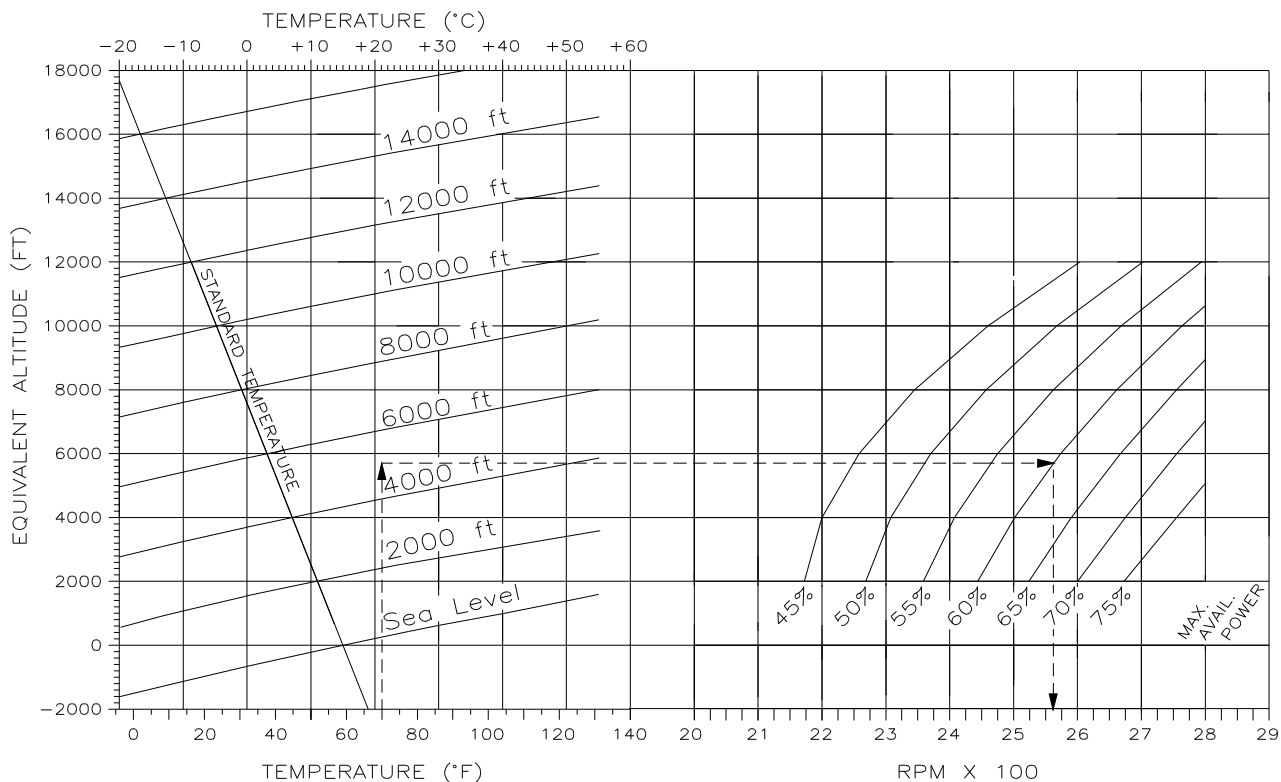

*Example:* OAT: 70° F  
 Pressure Altitude: 5000 ft  
 Desired Power setting: 60%

*Result:* Set RPM: 2560

### 5.3.3. Figure 5.3: Stall Speeds

Configuration:

Idle, most forward center of gravity, max. weight

(this is the most adverse configuration)

Stall speeds in **kts**

Flaps	Bank Angle							
	0°		30°		45°		60°	
	IAS	CAS	IAS	CAS	IAS	CAS	IAS	CAS
CRUISE	42	52	47	56	55	62	68	73
T/O	40	48	44	51	52	57	65	68
LDG	34	44	39	47	46	52	58	62



**5.3.4. Figure 5.4: Wind Components**

Maximum demonstrated crosswind component: 20 kts (37 km/h)

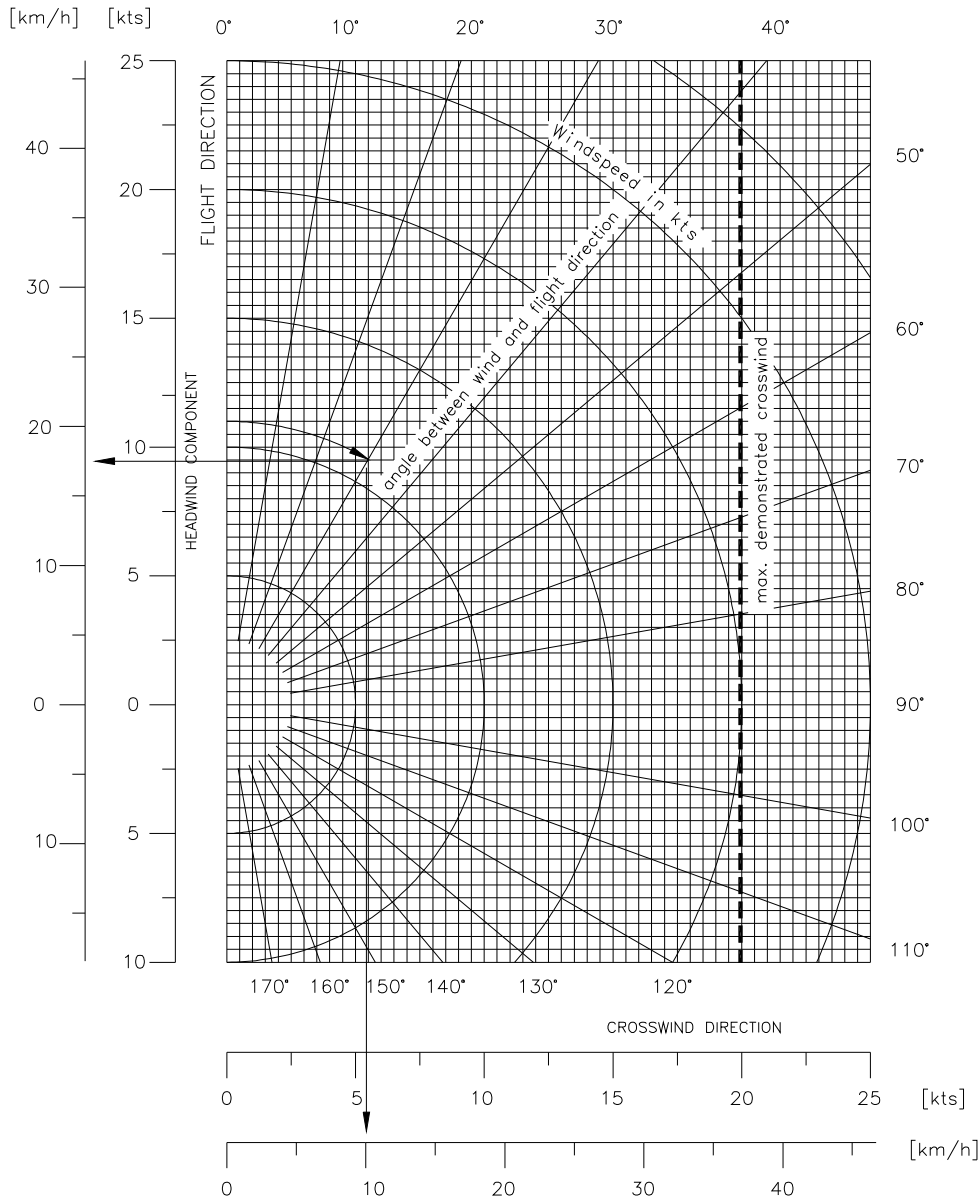

*Example:*

Wind speed:	11 kts (20 km/h)
Angle between wind direction and flight direction:	30°
Headwind component:	9.5 kts (18 km/h)
Crosswind component:	5.5 kts (10 km/h)

5.3.5 Figure 5.5(a): Take-off Distance

HOFFMANN PROPELLER HO-14HM-175-157

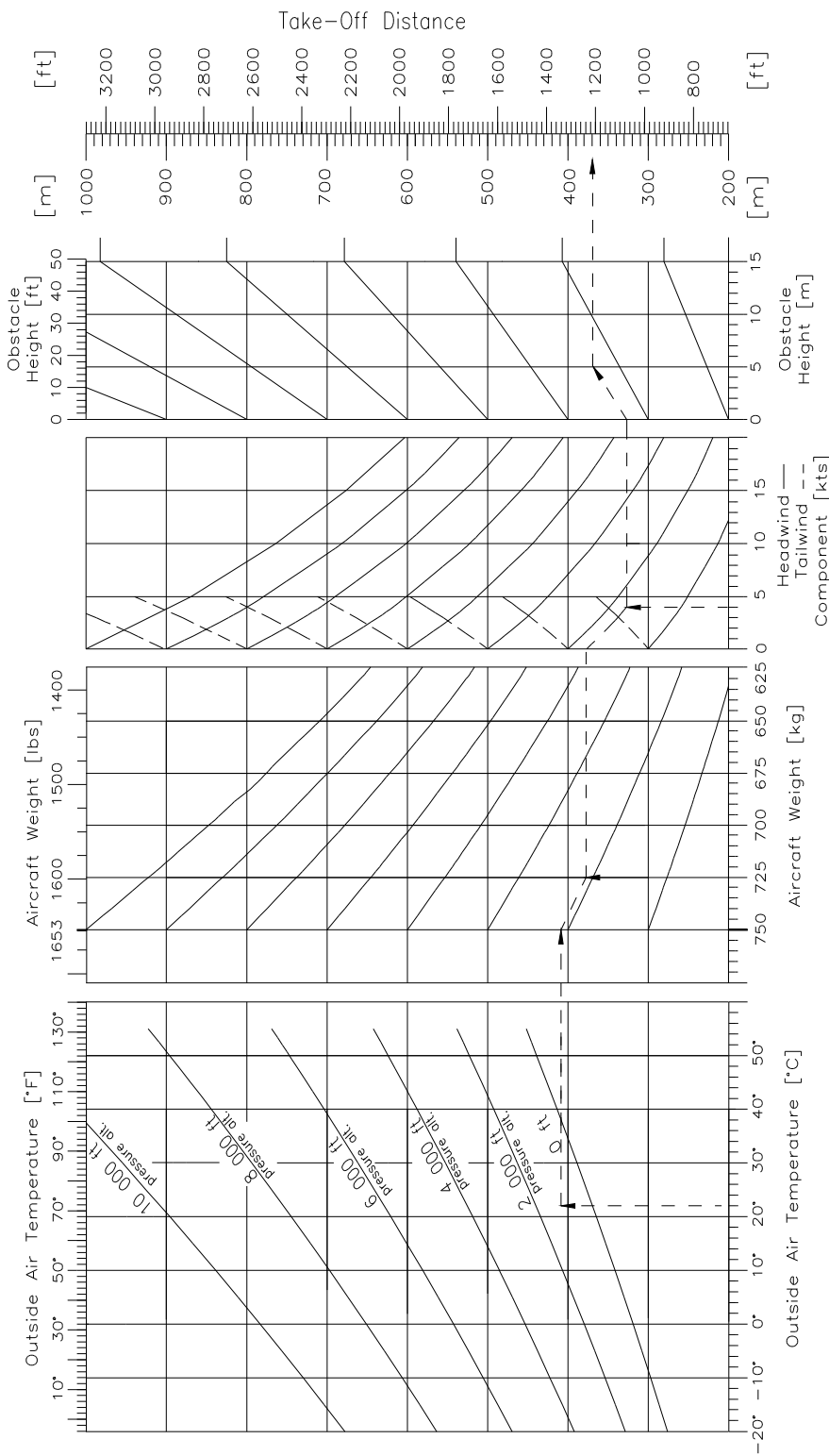

Conditions:

- Maximum take-off power
- Lift-off speed 52 KIAS and speed for climb over obstacle 58 KIAS
- Level runway, paved
- Wing Flaps in T/O position

Example:

- Pressure altitude: 1000 ft.
- Outside temperature: 72° F (22° C)
- Weight: 1600 lbs (725 kg)
- Wind: 4 kt headwind

Result:

- Take-off roll distance to clear a 16 ft (5m) obstacle: 1214 ft (370m)

NOTE

Poor maintenance condition of the airplane, deviation from the given procedures as well as unfavorable conditions (i.e. high temperature, rain, unfavorable wind conditions, including cross wind) can increase the take-off distance considerably

Figure 5.5(b): Take-off Distance

SENENICH PROPELLER

W69EK7-63, W69EK7-63G and W69EK-63

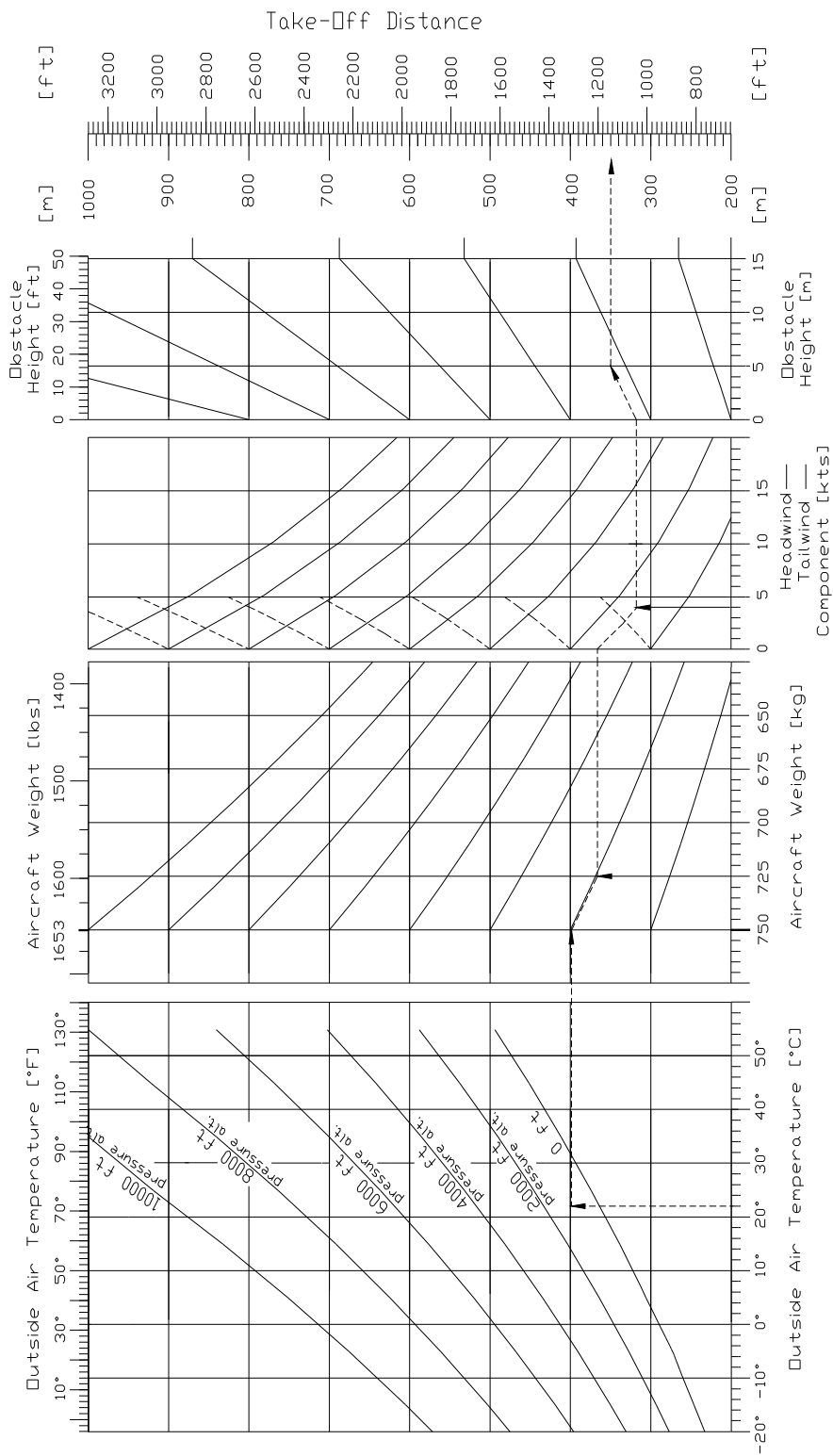

Conditions:

- Maximum take-off power
- Lift-off speed 52 KIAS and speed for climb over obstacle 58 KIAS
- Level runway, paved
- Wing Flaps in T/O position

Example:

- Pressure altitude: 1000 ft.
- Outside temperature: +72 F (+22 C)
- Weight: 1600 lbs (725 kg)
- Wind: 4 kt headwind

Result:

- Take-off roll distance to clear a 16 ft (5m) obstacle: 1148 ft (350m)

NOTE

Poor maintenance condition of the airplane, deviation from the given procedures as well as unfavorable conditions (ie. high temperature, rain, unfavorable wind conditions, including cross wind) can increase the take-off distance considerably

5.3.6. Figure 5.6(a): Climb Performance / Cruising Altitudes

HOFFMANN PROPELLER HO-14HM-175-157

Max. Cruising Altitude (in standard conditions): 13120 ft (4000 m)

Best Rate-of-Climb Speed with Wing Flaps CRUISE 75 KIAS

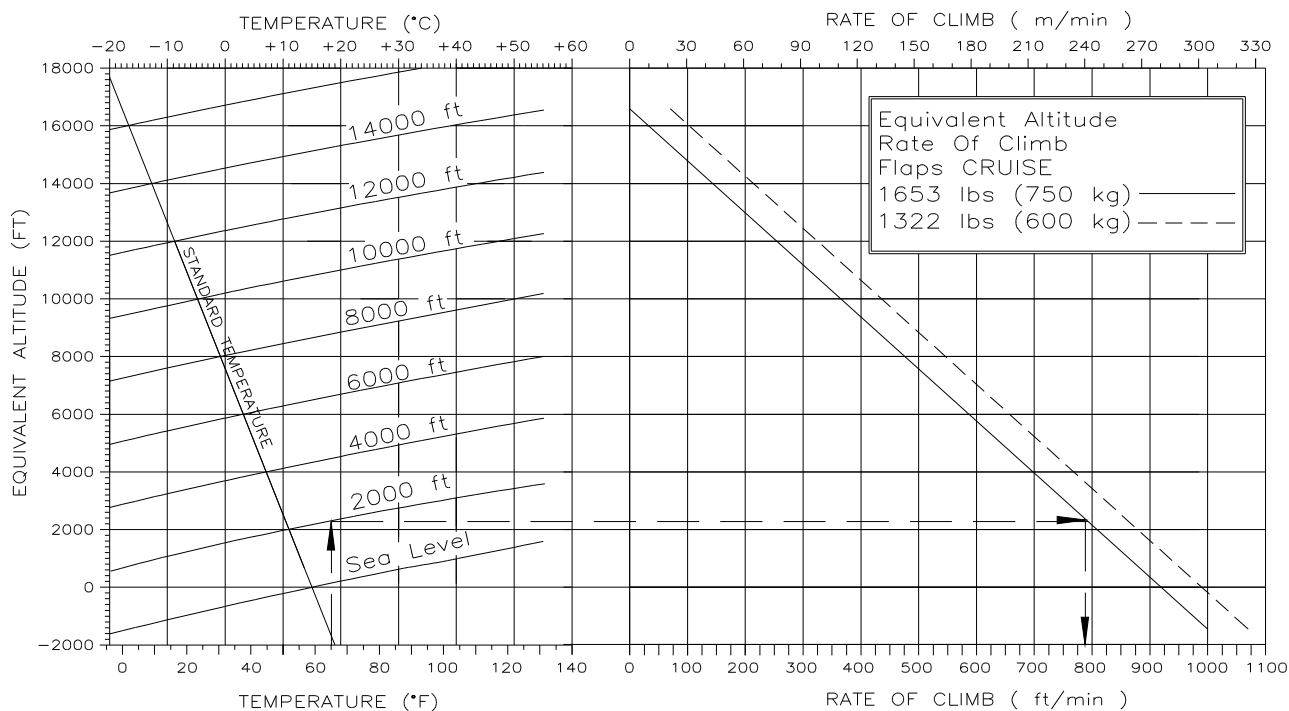

**Example:** Pressure Altitude: 2000 ft  
 OAT: 65° F  
 Weight : 1653 lbs  
**Result:** Climb performance: 785 ft/min

**Figure 5.6(b) : Climb Performance / Cruising Altitudes**

**SENENICH PROPELLER**

**W69EK7-63, W69EK7-63G and W69EK-63**

Max. Cruising Altitude (in standard conditions): 13120 ft (4000 m)

Best Rate-of-Climb Speed with Wing Flaps CRUISE 75 KIAS

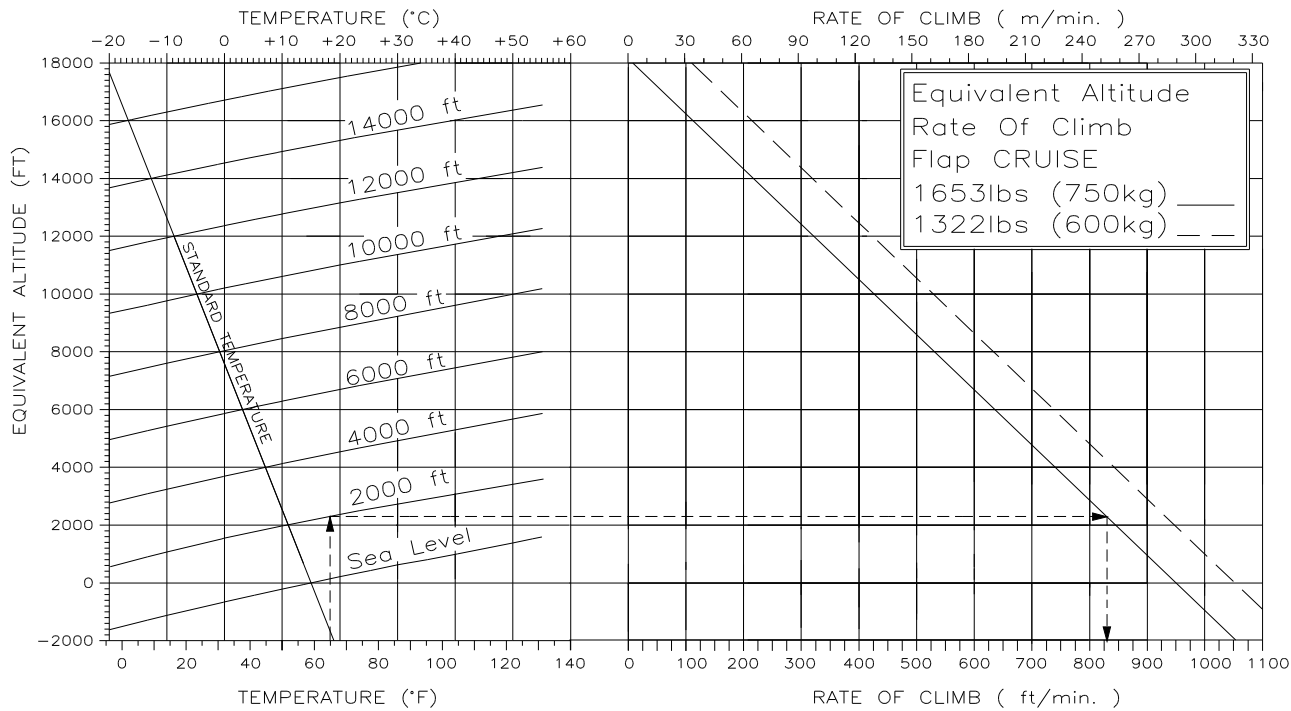

*Example:* Pressure Altitude: 2000 ft

OAT: 65° F

Weight : 1653 lbs

*Result:* Climb performance: 830 ft/min

5.3.7. Figure 5.7(a): Climb Performance / Take off

HOFFMANN PROPELLER HO-14HM-175-157

Best Rate-of-Climb Speed with Wing Flaps T/O

68 KIAS

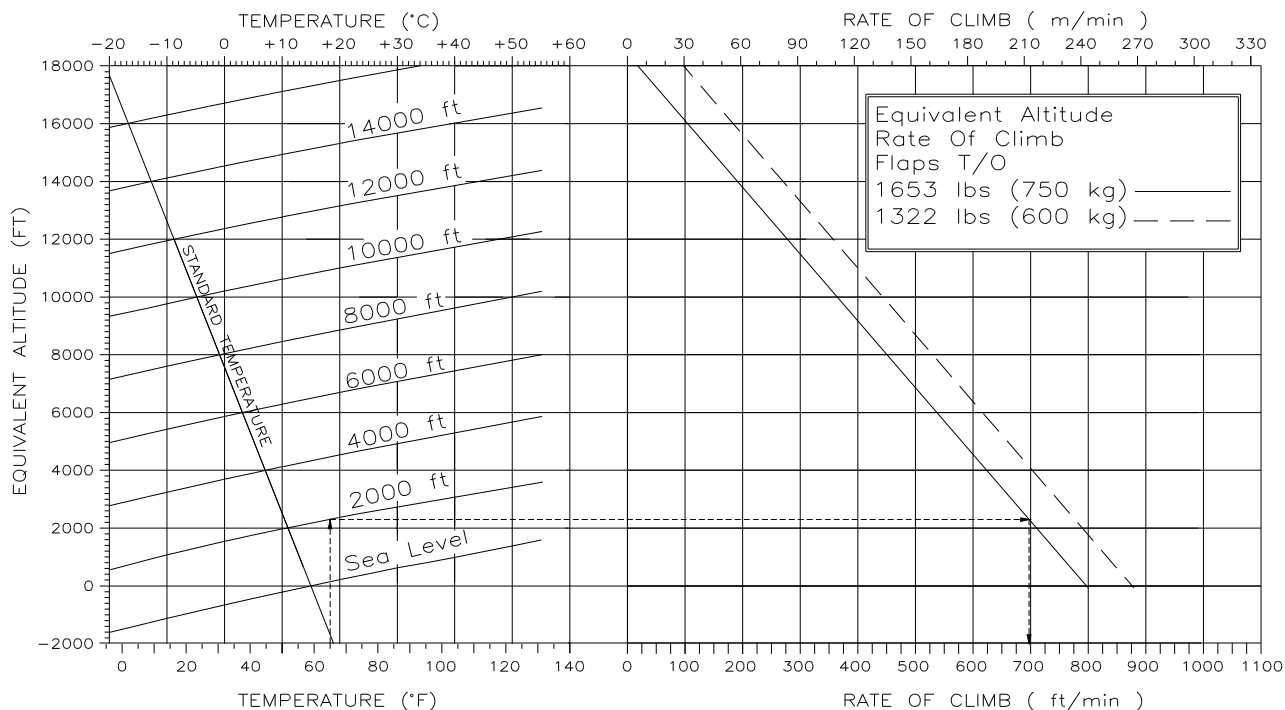

*Example:* Pressure Altitude: 2000 ft  
 OAT: 65° F  
 Weight : 1653 lbs  
*Result:* Climb performance: 695 ft/min

**Figure 5.7(b) : Climb Performance / Take off**

**SENENICH PROPELLER**

**W69EK7-63, W69EK7-63G and W69EK-63**

Best Rate-of-Climb Speed with Wing Flaps T/O

68 KIAS

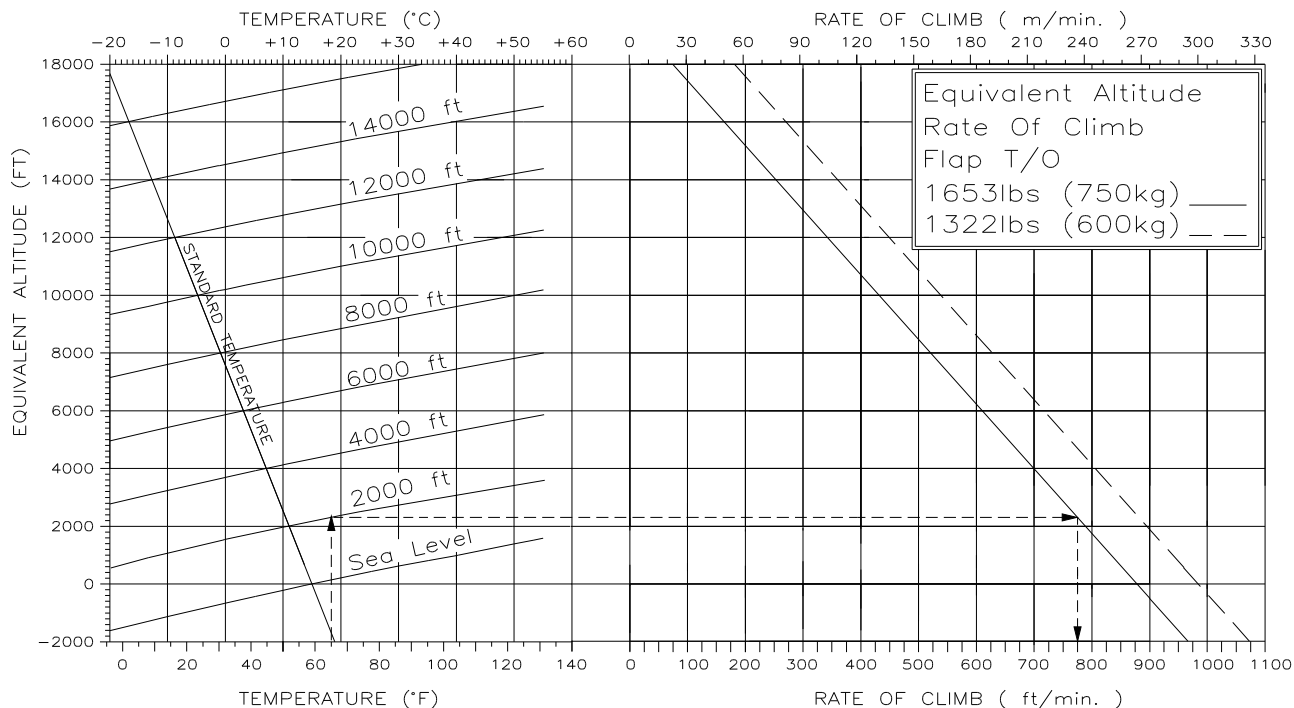

*Example:* Pressure Altitude: 2000 ft  
 OAT: 65° F  
 Weight : 1653 lbs  
*Result:* Climb performance: 775 ft/min

5.3.8 Figure 5.8(a): Cruising Speed (True Airspeed)

HOFFMANN PROPELLER HO-14HM-175-157

Diagram for true airspeed (TAS) calculation at selected power level.

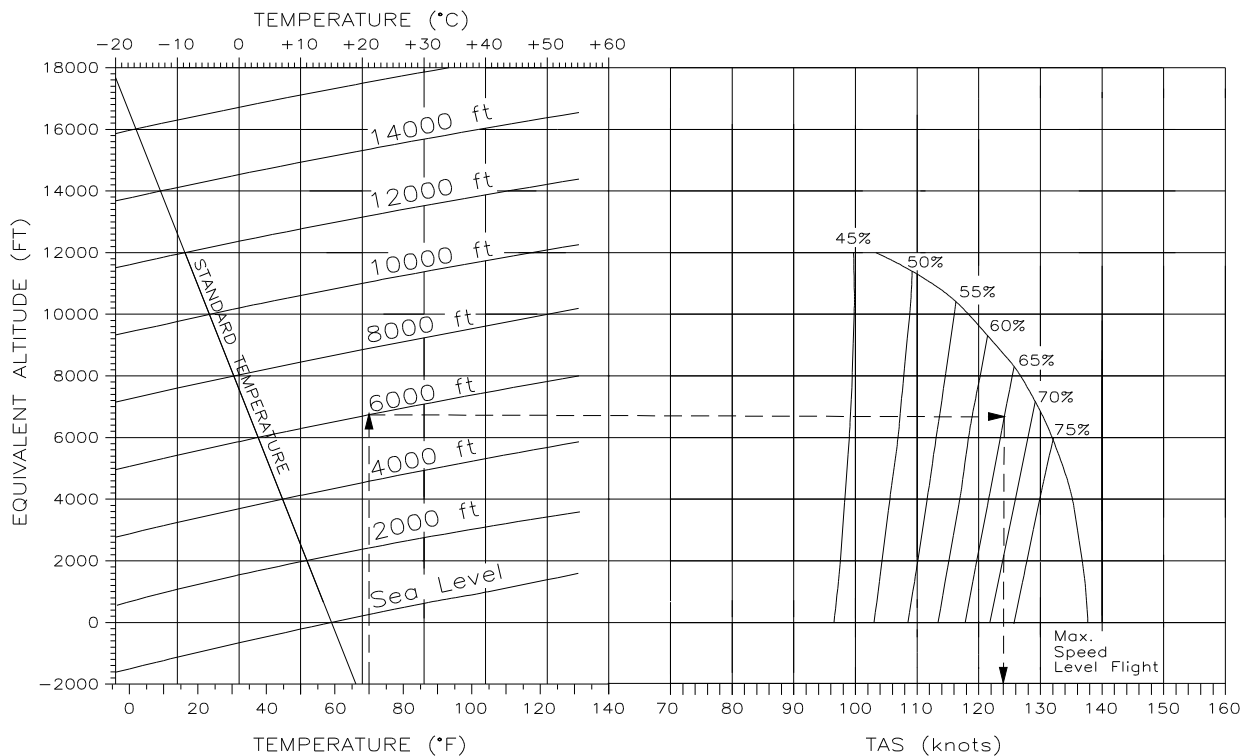

**Example:** Pressure altitude: 6000 ft.  
 Temperature: 70° F  
 Power setting: 65%

**Result:** True airspeed (TAS): 124 kts

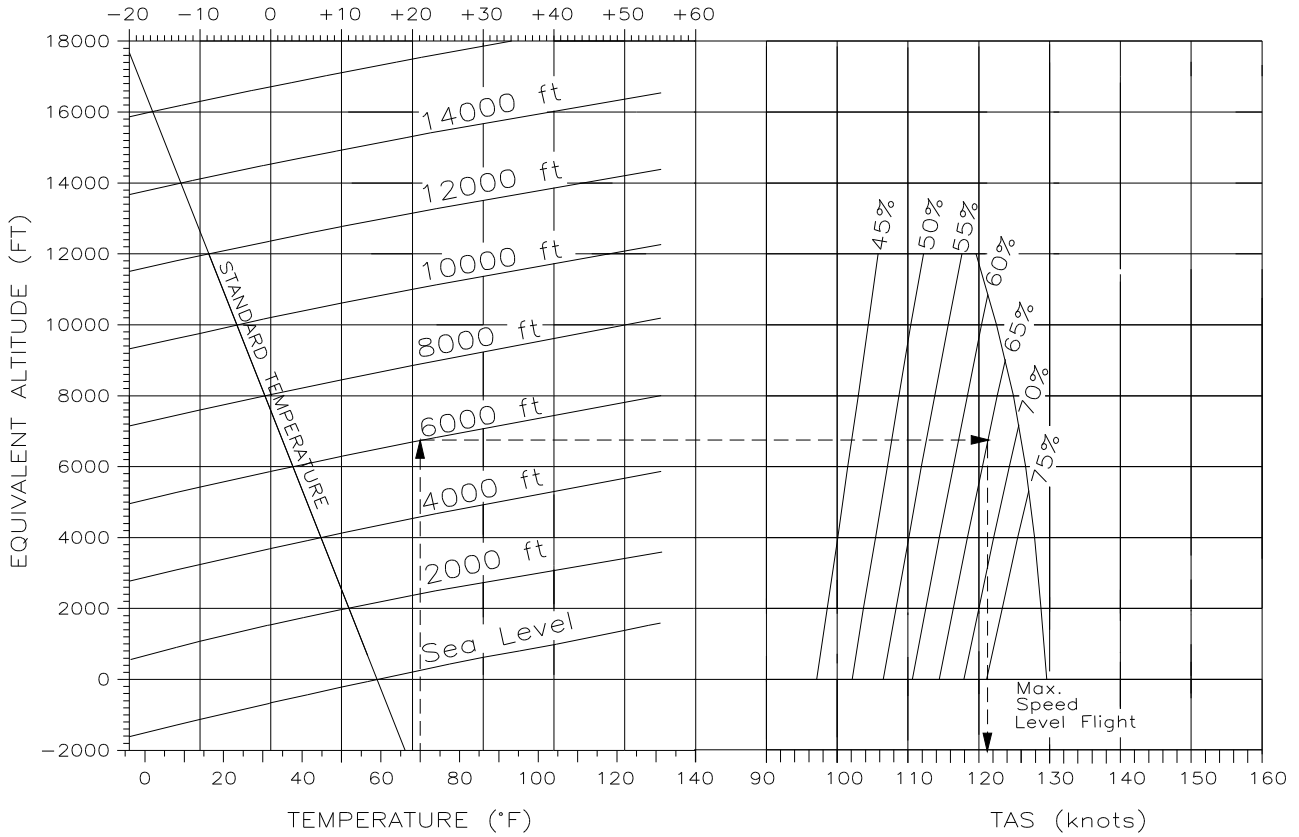

**Figure 5.8(b): Cruising Speed (True Airspeed)**

**SENENICH PROPELLER**

**W69EK7-63, W69EK7-63G and W69EK-63**

Diagram for true airspeed (TAS) calculation at selected power level.



**Example:** Pressure altitude: 6000 ft.  
 Temperature: 70° F  
 Power setting: 65%

**Result:** True airspeed (TAS): 121kts

**5.3.9. Figure 5.9(a): Maximum Flight Duration****HOFFMANN PROPELLER HO-14HM-175-157**

Diagram for calculation of the maximum flight duration depending on fuel availability.

TO BE INSERTED

*Example:* Fuel quantity:  
Power Setting:

*Result:* Possible flight time without reserve:  
Possible flight time with reserve of 45 mins:

**Figure 5.9(b) : Maximum Flight Duration**

**SENENICH PROPELLER W69EK7-63, W69EK7-63G and W69EK-63**

Table for calculation of the maximum flight duration depending on fuel availability.

**Figure 1: Flight Manual Cruise Performance Table, Sensenich Propeller**

Press Alt ft	RPM	20 °C Below Standard Temp			Standard Temperature			20 °C Above Standard Temp		
		% bhp	KTAS	GPH	% bhp	KTAS	GPH	% bhp	KTAS	GPH
2,000	2800	87	128	8.8	83	129	8.7	80	130	8.6
	2700	78	123	7.7	74	124	6.8	72	125	6.6
	2600	69	118	6.4	66	119	6.2	64	120	6.1
	2500	61	113	5.9	59	113	5.7	57	114	5.6
	2400	54	107	5.3	52	108	5.2	50	109	5.1
4,000	2800	79	126	8.6	76	127	8.6	74	129	6.8
	2700	71	121	6.6	68	122	6.4	66	123	6.2
	2600	63	116	6.0	61	117	5.9	59	118	5.7
	2500	56	111	5.5	55	112	5.4	53	113	5.3
	2450	53	108	5.3	51	109	5.1	50	110	5.1
6,000	2800	73	125	6.7	70	126	6.5	69	128	6.4
	2700	66	120	6.2	64	121	6.0	62	123	5.9
	2600	59	115	5.7	57	116	5.6	56	117	5.5
	2500	53	110	5.2	51	111	5.1	50	112	5.0
8,000	2800	68	124	6.4	66	125	6.2	65	127	6.1
	2700	61	119	5.9	60	121	5.8	59	122	5.7
	2600	55	114	5.4	54	116	5.3	53	117	5.3
	2550	53	112	5.2	51	113	5.1	50	114	5.1
10,000	2800	64	123	6.1	63	125	6.0	61	127	5.9
	2750	61	121	5.9	60	123	5.8	59	124	5.7
	2700	58	119	5.6	57	120	5.5	56	122	5.5
	2650	55	116	5.4	54	118	5.3	53	119	5.3
	2600	53	114	5.2	51	115	5.1	51	117	5.1
12,000	2800	61	123	5.8	60	125	5.8	59	127	5.7
	2750	58	121	5.6	57	123	5.6	56	124	5.5
	2700	55	118	5.4	54	120	5.4	53	122	5.3
	2650	53	116	5.2	52	118	5.2	51	119	5.1

**5.3.10. Figure 5.10(a): Climb Performance / Balked Landing**

**HOFFMANN PROPELLER HO-14HM-175-157**

Conditions: Speed = 52 KIAS  
 Wing Flaps in Landing Position (LDG)  
 max take-off power

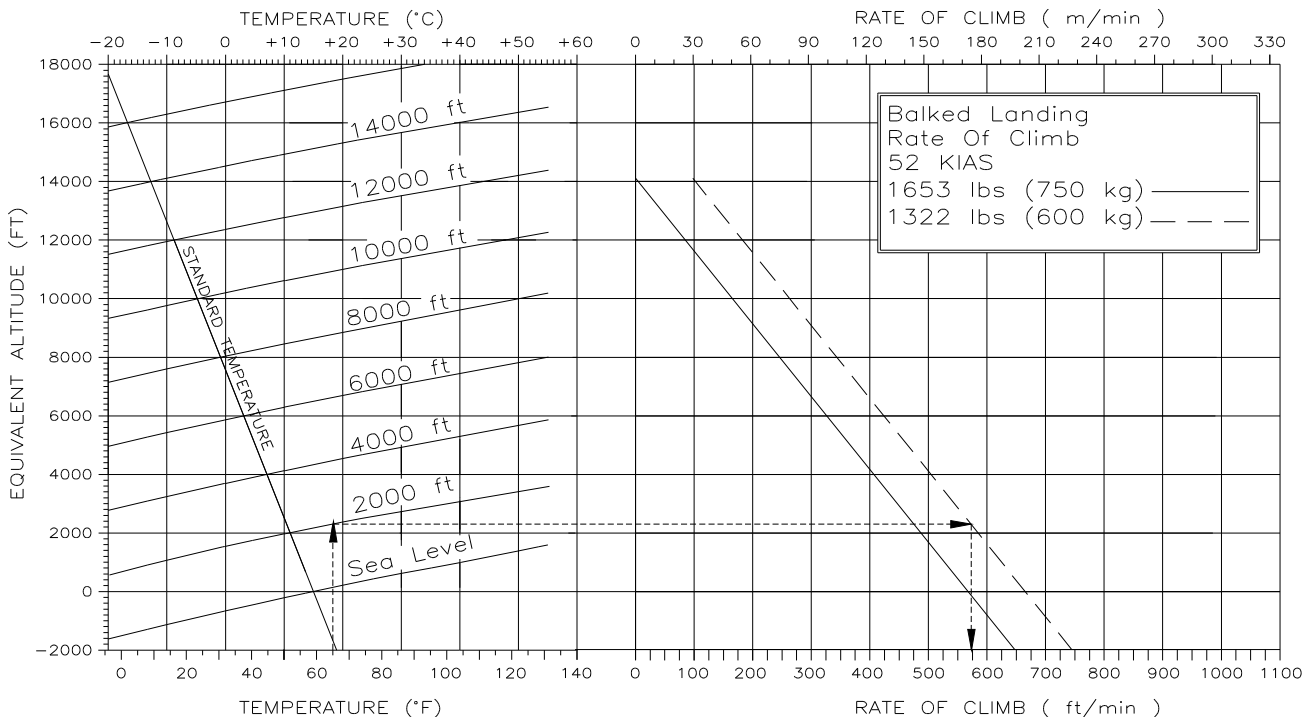

*Example:* Pressure altitude: 2000 ft  
 Outside temperature: 65°F

*Result:* Climb performance during balked landing: 575 ft/min

**Figure 5.10(b): Climb Performance / Balked Landing**

**SENSENICH PROPELLER**

**W69EK7-63, W69EK7-63G and W69EK-63**

Conditions: Speed = 52 KIAS  
 Wing Flaps in Landing Position (LDG)  
 max take-off power

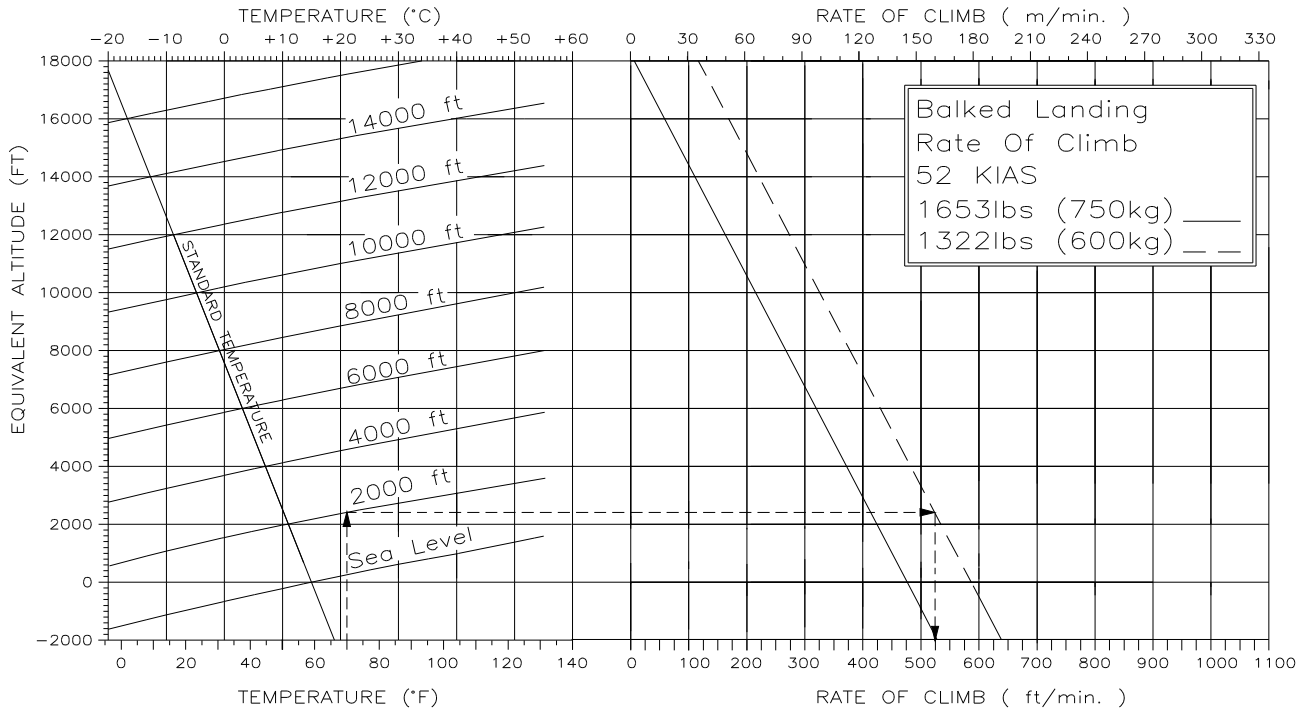

**Example:** Pressure altitude: 2000 ft  
 Outside temperature: 70°F

**Result:** Climb performance during balked landing: 525 ft/min

### 5.3.11. Landing Distance

- Conditions:
- Throttle: Idle
  - Maximum T/O Weight
  - Approach Speed                      52 KIAS
  - Level Runway, paved
  - Wing Flaps in Landing position (LDG)
  - Standard Setting, MSL

Landing distance over a 50 ft (15 m) obstacle:    approx. 1280 ft (390m)

Landing roll distance:                                      approx. 580 ft (177m)

Figure 5.11: Landing and Rolling Distances for Heights Above MSL

Height above MSL	ft. (m)	0 (0)	1000 (305)	2000 (610)	3000 (915)	4000 (1220)	5000 (1524)	6000 (1829)	7000 (2134)
<b>Landing Distance</b>	ft.	1280	1305	1332	1360	1388	1418	1449	1481
	(m)	390	398	406	414	423	432	442	451
<b>Landing Roll Distance</b>	ft.	581	598	616	635	654	674	695	716
	(m)	177	182	188	193	199	205	212	225

**NOTE**

Poor maintenance condition of the airplane, deviation from the given procedures as well as unfavorable outside conditions (i. e. high temperature, rain, unfavorable wind conditions, slippery runway) could increase the landing distance considerably.

**NOTE**

Aircraft with ground idle speed set to 1000 RPM, landing distance increased approx. 5% and ground roll increased approx. 7%

### 5.4 Noise Data

Noise Measurement Method	Hoffmann Propeller HO-14HM-175-157	Sensenich Propeller W69EK-63	Maximum Allowable
FAR36 Appendix G	69.3 dBA	71.4 dBA	75 dBA
ICAO Annex 16, Appendix 6	73.7 dBA	74.1 dBA	79.1 dBA

## CHAPTER 6

### WEIGHT AND BALANCE / EQUIPMENT LIST

<b>6.1 INTRODUCTION</b>	<b>6-2</b>
<b>6.2 AIRPLANE WEIGHING</b>	<b>6-3</b>
- Figure 6.1 Leveling Diagram	6-4
- Figure 6.2 Leveling Diagram	6-4
- Figure 6.3 Sample Weighing Report	6-5
<b>6.3 WEIGHT AND BALANCE REPORT</b>	<b>6-6</b>
- Figure 6.4 Sample Weight and Balance Report	6-7
<b>6.4 FLIGHT-WEIGHT AND CENTER OF GRAVITY</b>	<b>6-8</b>
- Figure 6.5 Loading Plan	6-8
- Figure 6.6 Weight & Balance Diagram	6-9
- Figure 6.7 Calculation of Loading Condition	6-10
- Figure 6.8 Permissible Center of Gravity Range and permissible Flight Weight-Moment	6-11
<b>6.5 EQUIPMENT LIST</b>	<b>6-12</b>

## 6.1. INTRODUCTION

To obtain the performance, flight characteristics and safe operation described in this Flight Manual, the airplane must be operated within the permissible weight and balance envelope as described in Chapter 2. It is the pilot's responsibility to adhere to the weight and balance limitations and to take into consideration the change of the CG position due to fuel consumption.

The procedure for weighing the airplane and calculating the empty weight CG position are given in this Chapter.

The aircraft is weighed when new and should be reweighed in accordance with applicable air regulations. Empty weight and the center of gravity are recorded in a Weighing Report and in the Weight & Balance Report, included at the back of this manual.

In case of equipment changes, the new weight and empty weight CG position must be determined by calculation or by weighting and must be entered in the Weight & Balance Report. The following pages are sample forms which can be used for airplane weighing, calculation of the empty weight CG position, and for the determination of the useful load.

<b>NOTE</b>
-------------

After every repair, painting or change of equipment the new empty weight must be determined as required by applicable air regulations. Weight, empty weight CG position and useful load must be entered in the Weight & Balance Report by an authorized person.



## 6.2. AIRPLANE WEIGHING

Pre-weighing conditions:

- equipment must be in accordance with the airplane equipment list
- brake fluid, lubricant (6 US qt / 5.7 liters) and
- unusable fuel, included (2 liters unusable, 3.18 lbs/1.44 Kg)

To determine the empty weight and the empty weight CG position, the airplane is to be positioned in the above mentioned pre-weighing condition, with the nose gear and each main gear on a scale. Ensure the aircraft is level longitudinally and laterally as illustrated in figure 6.1 and 6.2.

With the airplane correctly positioned, a plumb line is dropped from the leading edge of each wing at the root rib to the floor, join these two points to determine the reference datum (RD). From this line use a suspended plumb line aligned with each landing axle gear to measure the distances **X** (nose gear), **X<sub>2LH</sub>** (left main gear) and **X<sub>2RH</sub>** (right main gear).

The following formulas apply:

### Finding Empty - Center of Gravity (X<sub>CG</sub>)

Empty Weight: **G = G<sub>1</sub> + G<sub>2LH</sub> + G<sub>2RH</sub> lbs [kg]**

Empty Weight CG Formula:

$$X_{CG} = \frac{G_{LH} (X + X_{LH}) + G_{RH} (X + X_{RH})}{G + G_{LH} + G_{RH}} - X$$

### Finding Empty - Weight Moment

Empty-weight Moment **M = Empty Weight (G) x Empty-weight CG (X<sub>CG</sub>)**

Record the data in the Weighing Report included at the back of this manual. The following Sample Weighing Report (Figure 6.3) is for reference only.

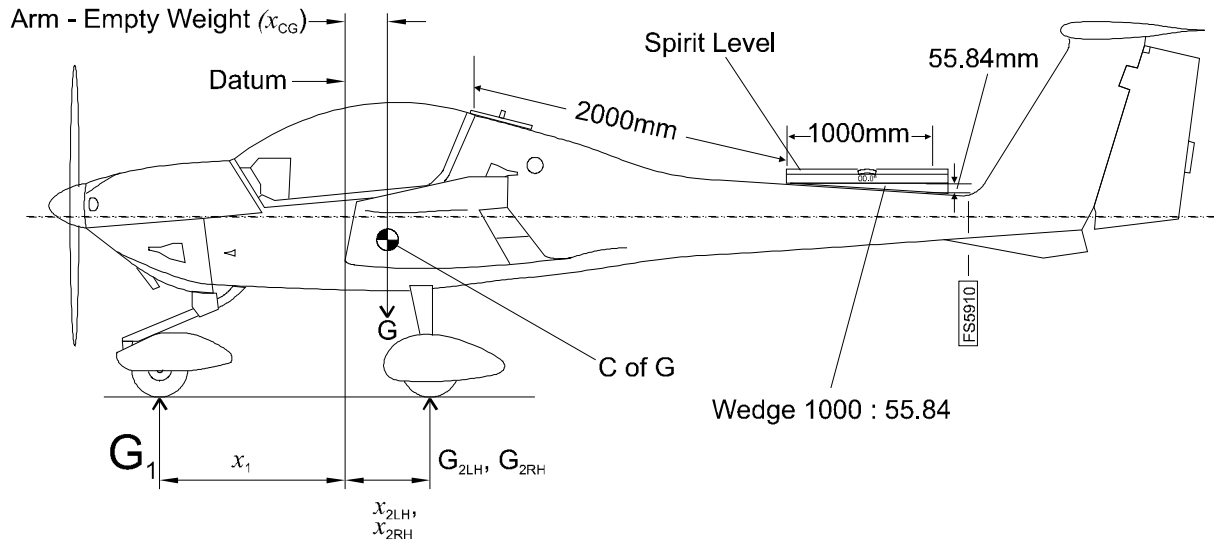

**Figure 6.1**

- Legend:
- $X_1$  = Arm - Datum to center line nose wheel
  - $X_2$  = Arm - Datum to C/L main wheels (LH and RH)
  - $G_1$  = Net weight - Nose wheel
  - $G_2$  = Net weight - Main wheels (LH and RH)
  - $G$  = Empty weight
  - $X_{CG}$  = Arm - Empty - weight (Calculated)

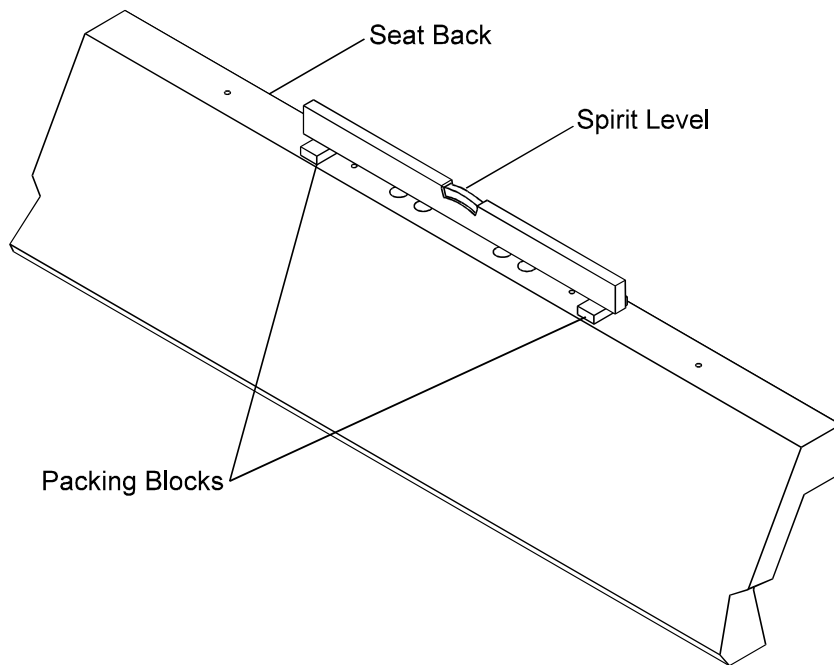

**Figure 6.2**

Model: DA20-C1 KATANA



Aircraft Serial No.:

Registration:

Issue date:

**Aircraft Specific Weighing Report**

Data with reference to the Type Certificate Data Sheet and the Flight Manual.

Reference Datum: Leading edge of wing at root rib.

Horizontal reference line: Wedge 1000:55.84, 2000mm (78.7 in) aft of the step in the fuselage at the canopy edge.

Equipment list - dated: \_\_\_\_\_ Cause for Weighing: \_\_\_\_\_

Weight and Balance Calculations

Weight Condition:

Include brake fluid, engine oil and Unusable fuel (Type 1 system, 14.5 liters unusable, 10.2 kg (22.5 lbs))  
(Type 2 system, 2 liters unusable, 1.44 kg (3.18 lbs))

Finding Empty Weight:

Finding Arm: (Measured)

Support	Gross kg (lbs)	Tare kg (lbs)	Net Weight kg (lbs)
Front G			
Rear G <sub>LH</sub>			
Rear G <sub>RH</sub>			
EMPTY WEIGHT (G)			

Lever Arm m (in)
X =
X <sub>LH</sub> =
X <sub>RH</sub> =

Finding Empty - Weight Center of Gravity (X<sub>CG</sub>):

Empty Weight CG Formula:

$$X_{CG} = \frac{G_{LH} (X + X_{LH}) + G_{RH} (X + X_{RH})}{G + G_{LH} + G_{RH}} - X = \underline{\hspace{2cm}}$$

Finding Empty - Weight Moment

Empty-weight Moment (M) = Empty Weight (G) x Empty-weight CG (X<sub>CG</sub>) = \_\_\_\_\_

(Positive results indicate, that CG is located aft of RD)

Finding Maximum Permitted Useful Load:

Maximum Weight kg (lbs)	750 kg (1653 lbs)
Empty Weight kg (lbs)	
Maximum useful Load kg (lbs)	

Empty Weight (G): kg (lbs)	Empty-weight Moment (M): kg·m (in·lbs)
-------------------------------	---

Place / Date	Authorizing Stamp	Authorizing Signature
--------------	-------------------	-----------------------

**Figure 6.3. Sample Weighing Report**

### 6.3. WEIGHT AND BALANCE REPORT

The empty weight and Empty Weight CG position data determined prior to delivery of the airplane is the first entry in the Weight and Balance Report. Each change of the installed equipment as well as each repair affecting the empty weight, the CG position of the empty weight or the empty weight moment must be entered in the Weight and Balance Report included at the back of this manual. The following Sample Weight and Balance Report (Figure 6.4) is for reference only.

Ensure that you are using the latest weight and balance information when performing a weight and balance calculation.



## 6.4. FLIGHT WEIGHT AND CENTER OF GRAVITY

The following data enables the pilot to operate the DA 20 within the required weight- and center of gravity limitations.

The following diagrams,

- Figure 6.5 Loading Plan
- Figure 6.6 Weight & Balance Diagram
- Figure 6.7 Calculation of Loading Condition
- Figure 6.8 Permissible Center of Gravity Range and permissible Flight-Weight-Moment

are to be used for calculations of the flight-weight and the center of gravity as follows:

1. The empty weight and the empty-weight-moment of the airplane should be taken from the weighing report or from the weight & balance report and entered into the form "Calculation of Loading Condition" (figure 6.7) in the columns identified with "Your DA 20".
2. Using the Weight & Balance Diagram (see figure 6.6) determine the moment for each part to be loaded, and enter it in the respective column in figure 6.7.
3. Add the weights and the moments of each column (point 4 and point 6 in figure 6.7) and enter the sum in figure 6.8 "Permissible CG Range and Permissible Flight-Weight-Moment" to check if the values are within the permissible limits of the loading range.

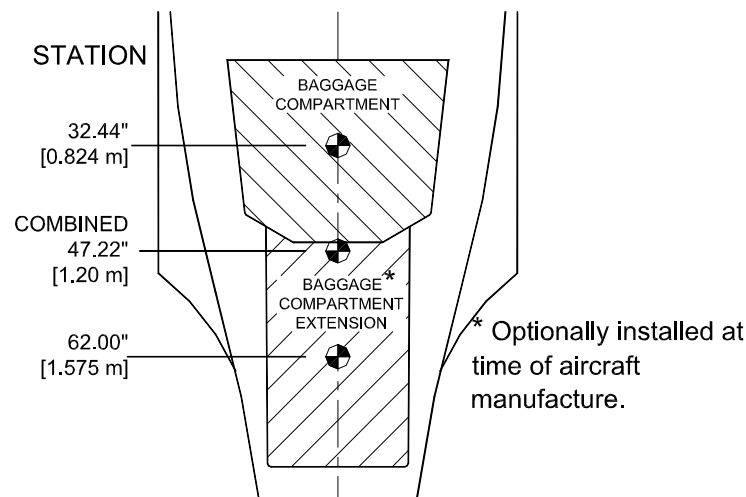

**Figure 6.5 Loading Plan**

**Figure 6.6: Weight & Balance Diagram**

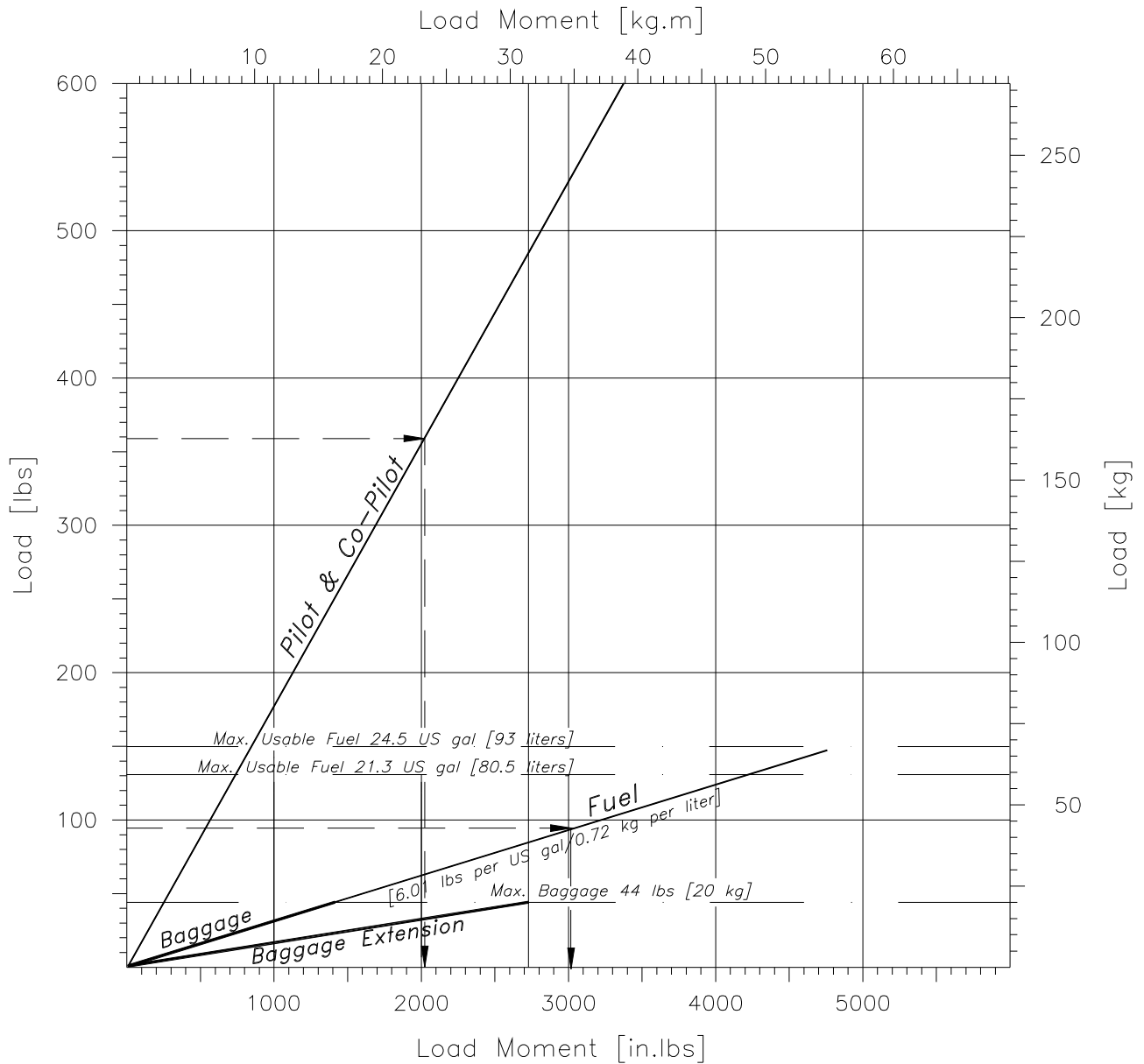

**Example:** Pilot and Passenger: 359 lbs. (163 kg)  
 Fuel 14.0 US gal. / 52.9 liters: 93 lbs. ( 42 kg)  
 (6.01 lbs. per US gal./0.72 kg per liter)

**Result:** Moment of Pilot and Passenger: 2021 in.lbs. (24.4 kgm)  
 Moment of Fuel: 3017 in.lbs. (34.8 kgm)

Figure 6.7: Calculation of Loading Condition

Calculation of the Load Limits	DA 20 (Example)		Your DA 20	
	Weight [lbs]	Moment [in.lbs]	Weight [lbs]	Moment [in.lbs]
	(Weight [kg])	([kgm])	(Weight [kg])	([kgm])
1. Empty Weight (use the data for your airplane recorded in the equipment list, including unusable fuel and lubricant).	1153 (523)	12562 (144.740)		
2. Pilot and Passenger: Lever Arm: 0.143 m (5.63 in)	359 (163)	2021 (23.286)		
3. Baggage: Max. Wt. 44lbs (20kg) Lever Arm: 0.824 m (32.44 in)	-- (--)	-- (--)		
4. Baggage Compartment Extension: Max. Wt. 44lbs (20kg) Lever Arm: 1.575 m (62.0 in)	-- (--)	-- (--)		
5. * Combined Baggage Max. Wt. 44lbs (20kg) Lever Arm: 1.20 m (47.22 in)	-- (--)	-- (--)		
6. Total Weight and Total Moment with empty fuel tank (sum of 1. - 3.)	<b>1512</b> <b>(686)</b>	<b>14583</b> <b>(168.026)</b>		
7. Usable Fuel Load (6.01 lbs. per US gal./0.72 kg per liter) Lever Arm (32.44 in) (0.824 m)	93 (42)	3017 (34.762)		
8. Total Weight and Total Moment, taking fuel into account (sum of 6. and 7.)	<b>1605</b> <b>(728)</b>	<b>17600</b> <b>(202.788)</b>		
9. Find the values for the total weight (1512 lbs. and 1605 lbs.) and the total moment (14583 in lbs. and 17600 in.lbs.) in the center of gravity diagram. Since they are within the limitation range, the loading is permissible.				

\* Combined Baggage: For convenience of calculation use this line if baggage is to be located in both the baggage compartment and the baggage extension. The combined total of the baggage must not exceed 44 lbs (20 kg).



**Figure 6.8: Permissible Center of Gravity Range and permissible Flight-Weight-Moment**

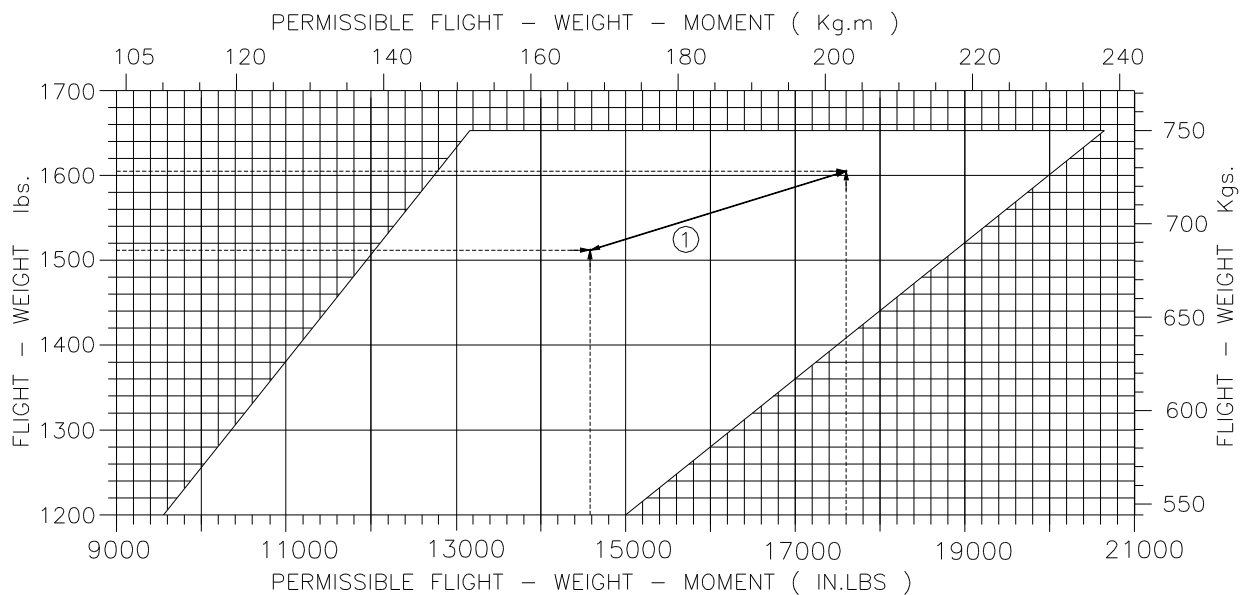

- ① See example calculation of loading condition Figure 6.7. Change in center of gravity is due to fuel consumption

## 6.5. EQUIPMENT LIST

The following table lists all the equipment available for this airplane. An Equipment Record of items installed in your specific airplane is included in the back of this manual.

The equipment list comprises the following data:

- The item No. containing an ATA Specification 100 reference number for the equipment group and a sequential number.

Weight and lever arm of the equipment items are shown in the columns "Weight" and "Arm".

<b>NOTE</b>
-------------

Additional installation of equipment must be carried out in compliance with the specifications in the Maintenance Manual. The columns "Weight" and "Arm" show the weight and the CG position of the equipment with respect to the reference datum. A positive value shows the distance aft of the reference datum, a negative value shows the distance forward of the reference datum.

Equipment List			
Item Number	Part Description Manufacturer Part/Model No.	Weight lbs (kg)	Arm in (m)
22-001	Autopilot Turn Coordinator/Roll Computer S-TEC 01260-12-0-14	2.2 (1.0)	-16.4 (-0.42)
22-002	Autopilot Pitch Computer S-TEC 01261-54-14	1.1 (0.5)	-27.4 (-0.68)
22-003	Autopilot Roll Servo S-TEC 0105-R2	2.9 (1.3)	+43.5 (+1.11)
22-004	Autopilot Pitch Servo S-TEC 0107-P4	2.9 (1.3)	+43.5 (+1.11)
23-001	GPS Antenna King KA 92	0.4 (0.1)	+64.0 (+1.63)
23-002	Intercom PS Engineering PM501	0.5 (0.2)	-15.5 (-0.39)
23-003	Nav / Com Bendix/King KX 125	3.9 (1.8)	-20.5 (-0.52)
23-004	VHF Comm Antenna Comant CI 122	0.5 (0.2)	+43.5 (+1.11)
23-005	Audio Panel Bendix/King KA 134	0.8 (0.4)	-16.4 (-0.42)
23-006	Audio Panel w/ Marker Receiver Bendix/King KMA 24	1.7 (0.8)	-17.2 (-0.44)
23-007	Nav / Com w/ GS Bendix/King KX 155	5.5 (2.5)	-19.5 (-0.49)
23-008	GPS/Comm Bendix/King KLX 135A	4.4 (2.0)	-20.5 (-0.52)
23-009	GPS Antenna Garmin GA56	0.4 (0.1)	+64.0 (+1.6)
23-010	GPS Antenna Garmin GPS 150	0.2 (0.1)	-20.5 (-0.52)
23-011	Audio Panel w/Marker Receiver PMA 6000	0.8 (0.4)	-17.2 (-0.44)
23-012	Audio Panel Garmin GMA 340	1.0 (0.4)	-20.5 (-0.52)
23-013	Com Bendix/King KY97A	2.8 (1.3)	-20.5 (-0.52)
23-014	Com Icom IC A200 TSO	2.4 (1.1)	-20.5 (-0.52)
23-015	Com GARMIN AT SL 40	2.1 (0.95)	-20.5 (-0.52)
24-001	Ammeter VDO 190-031SB	0.2 (0.1)	-16.4 (-0.42)
24-002	EPU Kit (S/N C0001-C0148, C0150) Diamond Service Bulletin # DAC1-24-02	4.5 (2.0)	+45.6 (+1.16)
24-003	Battery, GIL G-35M Diamond Service Bulletin # DAC1-24-03	26.3 (11.9)	+57.5 (+1.46)

<b>Equipment List</b>			
Item Number	Part Description Manufacturer Part/Model No.	Weight lbs (kg)	Arm in (m)
24-004	Battery, standard C0001-C0148, C0150 Yuasa Y50N18L-A-CX	15.3 (6.9)	+57.5 (+1.46)
	Battery, standard (S/NC0149, C0151 onwards) Yuasa Y50N18L-A-CX	15.3 (6.9)	-35.0 (-0.89)
24-005	EPU Installation (S/N C0149, C0151 onwards) Diamond Service Bulletin # DAC1-24-06	2.6 (1.2)	-23.6 (-0.6)
24-006	Battery, B&C Specialty Products BC100-1 (S/N C0001 to C0148,C0150)	22.5 (10.2)	+56.0 (+1.4)
25-001	Emergency Locator Transmitter EBC 502	2.8 (1.3)	+44.8 (+1.14)
25-002	Seat Cushion, standard RH 22-2510-20-00 , LH 22-2510-19-00	4.5 (2.1)	+12.0 (+0.30)
25-003	Seat Cushion, leather RH 22-2510-10-00 , LH 22-2510-09-00	5.6 (2.6)	+12.0 (+0.30)
25-004	Fire Extinguisher AMEREX A620	2.3 (1.0)	+28.0 (+0.71)
25-005	ELT Installation Artex ELT-200 (Includes ELT, Antenna, Remote Switch and Harness)	3.2 (1.5)	+158.0 (+4.0)
28-001	Fuel Quantity Indicator 22-2840-00-00	0.2 (0.1)	-16.4 (-0.42)
28-002	Auxiliary Fuel Quantity Indicator VDO 301-035	0.2 (0.1)	-16.4 (-0.42)
31-001	Hour Meter Hobbs 85000	0.5 (0.2)	-15.5 (-0.39)
31-002	Chronometer Davtron M800	0.2 (0.1)	-15.5 (-0.39)
31-003	Chronometer Davtron M803	0.3 (0.1)	-15.5 (-0.39)
32-001	Wheel Fairing, Main Gear RH 22-3210-06-00 , LH 22-3210-05-00	2.7 (1.2)	+27.6 (+0.70)
	Wheel Fairing, Nose Gear 20-3220-13-00	2.7 (1.2)	-44.8 (-1.14)
33-001	Recognition Light Kit Diamond Service Bulletin # DAC1-33-01	2.5 (1.1)	0 (0)
33-002	Light Dimmer Module White Wire WW-LCM 001	0.6 (0.3)	-16.4 (-0.42)
33-003	Flood Light Aero Enhancements	0.6 (0.3)	-16.4 (-0.42)
34-001	Encoder SSD 120-20	0.8 (0.4)	-22.5 (-0.57)
34-002	Encoder SSD 120-30	0.6 (0.3)	-22.5 (-0.57)
34-003	Nav Indicator King KI 208	1.1 (0.5)	-16.4 (-0.42)
34-004	Outside Air Temperature Indicator (F) Davtron 301F	0.5 (0.2)	-15.5 (-0.39)
34-005	Outside Air Temperature Indicator (C) Davtron 301C	0.5 (0.2)	-15.5 (-0.39)

<b>Equipment List</b>			
Item Number	Part Description Manufacturer Part/Model No.	Weight lbs (kg)	Arm in (m)
34-006	Transponder Bendix/King KT 76A	3.0 (1.4)	-20.5 (-0.52)
34-007	GPS Garmin GPS150	2.1 (1.0)	-20.5 (-0.52)
34-008	GPS Bendix/King KLN 35A	2.1 (1.0)	-20.5 (-0.52)
34-009	Nav Indicator King KI 209	1.2 (0.5)	-17.4 (-0.44)
34-010	Transponder Antenna KA 60	0.2 (0.1)	+54.1 (+1.37)
34-011	Altimeter United 5934PD3	0.9 (0.4)	-16.4 (-0.42)
34-012	Compass Airpath C2300L4	0.8 (0.3)	-15.0 (-0.38)
34-013	Turn Coordinator MCI 1394T100-7Z	1.2 (0.5)	-16.4 (-0.42)
34-013a	Turn Coordinator MCI 1394T100-7B	1.4 (0.64)	-16.4 (-0.42)
34-014	Airspeed Indicator United 8000B800	0.7 (0.3)	-16.4 (-0.42)
34-015	Vertical Speed Indicator United 7000	0.8 (0.4)	-16.4 (-0.42)
34-016	Artificial Horizon Sigma Tek 23-501-06-16	2.0 (0.9)	-16.4 (-0.42)
34-017	Artificial Horizon Sigma Tek 23-501-035-5	2.3 (1.0)	-16.4 (-0.42)
34-018	Directional Gyro Sigma Tek 1U262-001-39	2.6 (1.2)	-16.4 (-0.42)
34-019	Directional Gyro Sigma Tek 1U262-007-40	2.7 (1.2)	-16.4 (-0.42)
34-020	Vacuum Gauge Varga 5001	0.3 (0.1)	-16.4 (-0.42)
34-021	Marker Beacon Antenna KA 26	0.5 (0.2)	+13.6 (+0.35)
34-022	Transponder Antenna Bendix/King KA60	0.2 (0.1)	-38.5 (-1.0)
34-023	Transponder Garmin GTX320	1.6 (0.7)	-18.0 (-0.45)
34-024	Transponder Bendix/King KT76C	3.0 (1.3)	-20.5 (-0.52)
34-025	Digital Transponder Garmin GTX 327	2.2 (1.0)	-20.5 (-0.52)
34-026	GPS/Nav/Com Garmin GNS 430	6.5 (3.0)	-20.5 (-0.42)
34-027	GPS/Com Garmin GNC 420	5.8 (2.6)	-20.5 (-0.42)
34-028	GPS/Com Garmin GNC 300XL	3.4 (1.5)	-20.5 (-0.42)
Doc # DA202-C1 Revision 21		September 5, 2006	Page 6 - 15

### Equipment List

Item Number	Part Description Manufacturer Part/Model No.	Weight lbs (kg)	Arm in (m)
34-029	TCAD (Traffic Collision Alerting Device) Ryan 8800 Gold	3.6 (1.6)	-20.5 (-0.42)
34-030	CDI Garmin GI106A	1.4 (0.6)	-17.40 (-0.44)
34-031	GPS/Nav/Com Garmin GNS 530	8.5 (3.8)	-20.5 (-0.42)
34-032	Traffic Advisory System Processor Avidyne 70-2420-7 TAS600	6.8 (3.1)	55.5 (1.41)
34-033	Traffic Advisory System Antenna, Top Sensor Systems S72-1750-31L	0.66 (0.30)	64.6 (1.64)
34-034	Traffic Advisory System Antenna, Bottom Sensor Systems S72-1750-32L	0.75 (0.34)	7.9 (0.20)
34-035	Traffic Advisory System Transponder Coupler Avidyne 70-2040	0.5 (0.23)	56.7 (1.44)
61-001	Propeller and Spinner Hoffmann HO-14HM-175-157	12.1 (5.5)	-60.8 (-1.54)
61-002	Propeller and Spinner Sensenich W69EK-63	11.9 (5.4)	-60.8 (-1.54)
61-003	Propeller and Spinner Sensenich W69EK7-63 and W69EK7-63G	12.7 (5.7)	-60.8 (-1.54)
71-001	Heater Tanis TAS100-29	1.1 (0.5)	+45.5 (+1.16)
71-002	Winter Kit Diamond Service Bulletin # DAC1-71-01	0.4 (0.2)	-33.5 (-0.85)
73-001	Fuel Pressure Indicator 22-7330-00-01	0.3 (0.1)	-15.5 (-0.39)
77-001	Cylinder Head Temp. Indicator 22-7720-00-00	0.3 (0.1)	-16.4 (-0.42)
77-002	RPM Indicator 22-7710-20-00 or Mitchell CD-122-4020	0.8 (0.4)	-16.4 (-0.42)
77-003	RPM Indicator – Recording Superior Labs SL1010-55000-13-N00	0.8 (0.4)	-16.4 (-0.42)
77-004	Vision Microsystems VM-1000 4010050 Main Display	0.8 (0.4)	-16.4 (-0.42)
77-005	Vision Microsystems VM-1000 4010320 Fuel Display	0.2 (0.1)	-16.4 (-0.42)
77-006	Vision Microsystems VM-1000 4010055 EC 100	0.7 (0.3)	-16.4 (-0.42)
77-007	Vision Microsystems VM-1000 4010066 Data Processing Unit	1.3 (0.6)	-20.0 (-0.51)
77-008	Lighted RPM Indicator – Recording Superior Labs SL1010-5503-13-H03	0.7 (0.3)	-16.4 (-0.42)
78-001	EGT Indicator 22-7720-00-02	0.3 (0.1)	-15.5 (-0.39)
79-001	Oil Pressure Indicator 22-7930-00-03	0.3 (0.1)	-16.4 (-0.42)
79-002	Oil Temperature Indicator 22-7930-00-01	0.3 (0.1)	-16.4 (-0.42)

---

**CHAPTER 7**

**DESCRIPTION OF THE AIRPLANE**

**AND ITS SYSTEMS**

<b>7.1</b>	<b>INTRODUCTION</b>	<b>7-2</b>
<b>7.2</b>	<b>AIRFRAME</b>	<b>7-2</b>
<b>7.3</b>	<b>FLIGHT CONTROLS</b>	<b>7-3</b>
<b>7.4</b>	<b>INSTRUMENT PANEL</b>	<b>7-6</b>
<b>7.5</b>	<b>LANDING GEAR SYSTEM</b>	<b>7-8</b>
<b>7.6</b>	<b>SEATS AND SAFETY BELTS</b>	<b>7-10</b>
<b>7.7</b>	<b>BAGGAGE COMPARTMENT</b>	<b>7-10</b>
<b>7.8</b>	<b>CANOPY</b>	<b>7-11</b>
<b>7.9</b>	<b>POWERPLANT</b>	<b>7-12</b>
<b>7.10</b>	<b>FUEL SYSTEM</b>	<b>7-15</b>
<b>7.11</b>	<b>ELECTRICAL SYSTEM</b>	<b>7-19</b>
<b>7.12</b>	<b>PITOT AND STATIC PRESSURE SYSTEMS</b>	<b>7-22</b>
<b>7.13</b>	<b>STALL WARNING SYSTEM</b>	<b>7-22</b>
<b>7.14</b>	<b>AVIONICS</b>	<b>7-22</b>

## 7.1 INTRODUCTION

This Chapter provides description and operation of the airplane and its systems. Refer to Chapter 9 (Supplements), for details of optional systems and equipment.

## 7.2 AIRFRAME

### 7.2.1. Fuselage

The GFRP-fuselage is of semi-monocoque construction. The fire protection cover on the fire wall is made from a special fire retarding ceramic fiber, that is covered by a stainless steel plate on the engine side. The main bulkhead is of CFRP/GFRP construction. The instrument panel is made of aluminum.

### 7.2.2. Wings

The GFRP-wings are of semi-monocoque sandwich construction, and contain a CFRP-spar. The ailerons and flaps are made from CFRP and are attached to the wings using stainless steel and aluminum hinges. The wing-fuselage connection is made with three bolts each. The A- and B- bolts are fixed to the fuselage's root rib. The A-bolt is placed in front of the spar bridge, the B-bolt is near the trailing edge on each side of the fuselage. The two main bolts are placed in the middle of the spar bridge structure. They are accessible behind the seats and are inserted from the front side. A spring-loaded hook locks both bolt handles, securing them in place.

### 7.2.3. Empennage

The rudder and elevator units are of semi-monocoque sandwich construction. The vertical stabilizer contains a di-pole antenna for the VHF radio equipment, the horizontal stabilizer contains an antenna for the NAV equipment (VOR).



## 7.3 FLIGHT CONTROLS

The ailerons and elevator are actuated via push rods. The rudder is controlled using control cables. The flaps have three positions, CRUISE, T/O (take-off), LDG (landing) and are electrically operated. The switch is located on the instrument panel. The flap control circuit breaker can be manually 'tripped' to disable the flap system. Elevator forces may be balanced using the electric trim system.

### 7.3.1. Trim System

The Rocker switch is located on center console behind the throttle quadrant. The digital trim indicator is located in the upper instrument panel.

The switch controls an electrical actuator beside the vertical push rod in the vertical stabilizer. The actuator applies a load to compression springs on the elevator pushrod. The trim circuit breaker is located in the circuit breaker panel and can be tripped manually to disable the system.

switch forward = nose down

### 7.3.2. Flaps

The flaps are driven by an electric motor. The flaps are controlled by a three position flap operating switch on the instrument panel. The three positions of the switch correspond to the position of the flaps. The top position of the switch is used during cruise flight. When the switch is moved to a different position, the flaps move until the selected position is reached. The cruise (fully retracted) and landing (fully extended) positions are equipped with position switches to prevent over-traveling.

The electric flap actuator is protected by a circuit breaker (5 Amp), located on the right side of the instrument panel, which can be manually tripped to disable the system.

### 7.3.3. Flap Position Indicator

The current flap position is indicated by three control lights beside the flap operating switch.

Wing Flap Position	Light	Degree
CRUISE	green	0°
T/O	yellow	15°
LDG	yellow	45°

When two lights are illuminated at the same time, the flaps are in-between positions.

### 7.3.4. Pedal Adjustment

#### NOTE

The pedals may only be adjusted on the ground.

The pedals for rudder and brakes are unlocked by pulling the T-grip located in front of the rudder pedal sledge tubes.

Forward adjustment: Push both pedals forward with your feet while pulling lightly on the T-grip to disengage the latch.

Backward adjustment: Pull pedals backward to desired position by pulling on T-grip.

#### NOTE

After the T-grip is released, push the pedals forward with your feet until they lock in place.

### 7.3.5. Flight Control Lock

A flight control lock, P/N 20-1000-01-00 , is provided with each aircraft and should be installed whenever the aircraft is parked.

#### NOTE

Failure to install the flight control lock whenever the aircraft is parked may result in control system damage, due to gusts or turbulence.

Installation and Removal of the Control Lock:

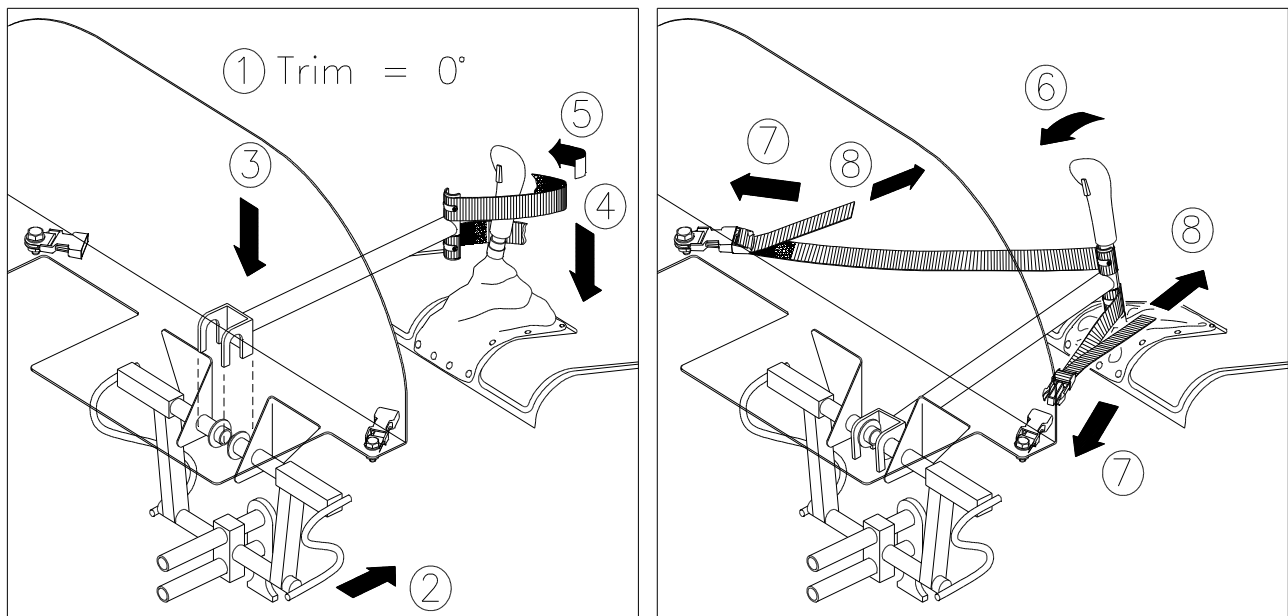

1. Trim aircraft to neutral.
2. Pull the left rudder pedals fully aft and check they are locked in position.
3. Hook the Control Lock's forks over the rudder pedal tubes as shown above.
4. Push down the Control Stick's leather boot to expose the Control Stick tube, and push the Control Stick forward against the Control Lock.
5. Loop the straps around the Control Stick as shown, and push forward on the Control Stick.
6. Clip the straps into the left and right buckle receptacles located under the instrument panel.
7. Adjust the straps as required. Straps should be tight to secure the controls properly.
8. **TO REMOVE**, push the Control Stick forward (to relieve strap tension). Unclip the straps and remove the Control Lock. Store in the aircraft's baggage compartment.

## 7.4 INSTRUMENT PANEL

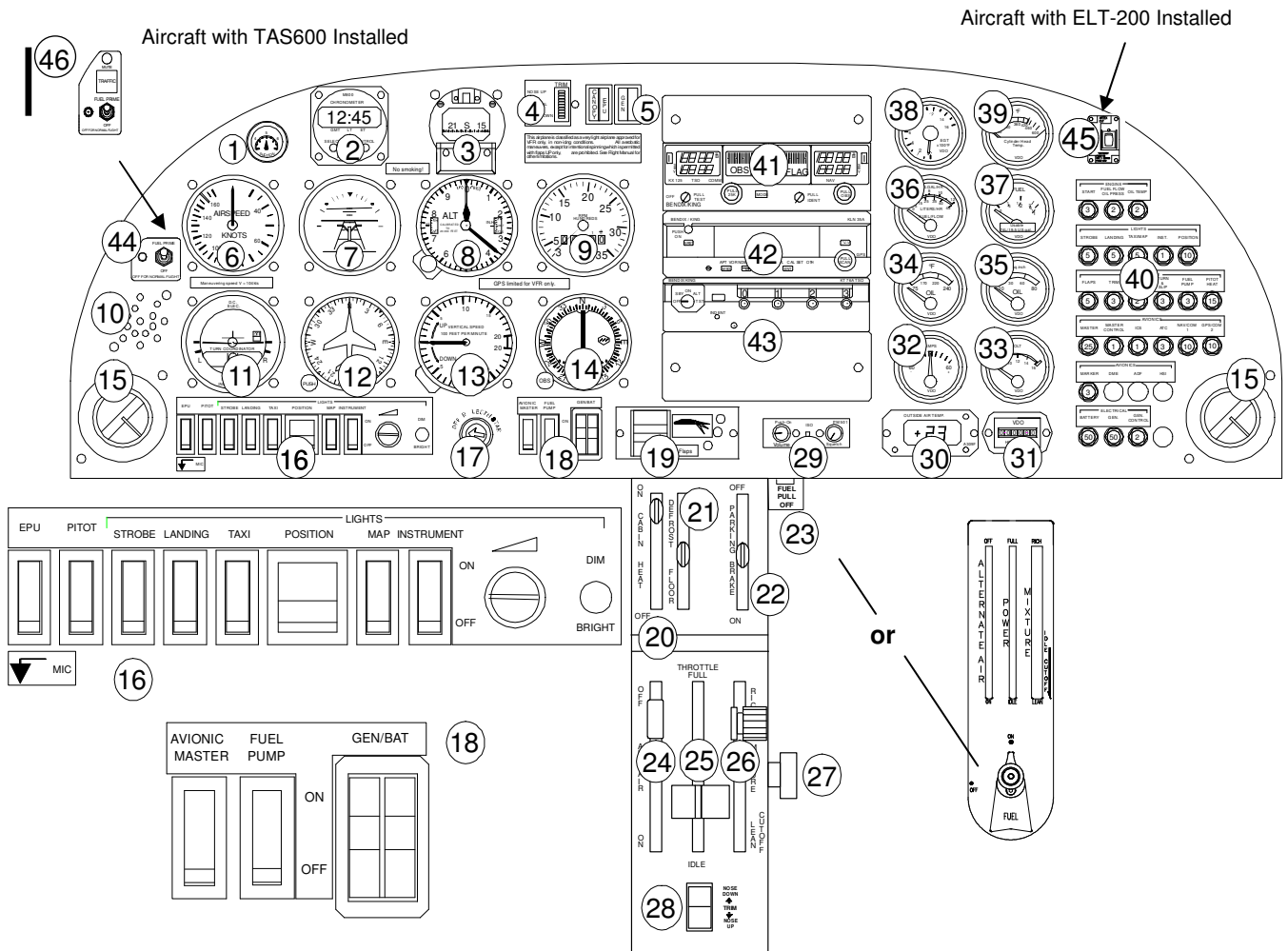

Item	Description	Item	Description	Item	Description	Item	Description
1.	Vacuum Gauge	13.	Vertical Speed Ind.	25.	Throttle Lever	37.	Fuel Quantity Ind.
2.	Clock (optional)	14.	CDI	26.	Fuel Mixture Lever	38.	EGT Indicator
3.	Magnetic Compass	15.	Air Vent	27.	Lever Friction Knob	39.	CHT Indicator
4.	Trim Position Display	16.	Switch Panel	28.	Trim Switch	40.	Circuit Breakers
5.	Annunciator Lights	17.	Ignition/Start Sw.	29.	Intercom	41.	Nav/Comm
6.	Airspeed Indicator	18.	Master Sw. Panel	30.	Outside Air Temp. Ind.	42.	GPS
7.	Artificial Horizon Ind,	19.	Flap Control	31.	Hour Meter	43.	Transponder
8.	Altimeter	20.	Cabin Heat Control	32.	Ammeter	44.	Fuel Prime Switch
9.	Tachometer	21.	Defrost/Floor Lever	33.	Voltmeter	45.	ELT Remote Switch (Artex ELT-200)
10.	Stall Warning Horn	22.	Parking Brake Lever	34.	Oil Temp. Ind.	46.	Traffic Advisory System Switch (TAS600)
11.	Turn Coordinator	23.	Fuel Shutoff Handle	35.	Oil Pressure Ind.		
12.	Directional Gyro	24.	Alternate Air Lever	36.	Fuel Pressure Ind.		

#### 7.4.1. Flight Instruments

The flight instruments are installed on the pilot's side of the instrument panel.

#### 7.4.2. Cabin Heat

The cabin heat and defrost system, directs ram air through the exhaust heat shroud into the cabin heat valve. The warm air is then directed to the window defrosting vents and to the cabin floor as selected by the Floor/Defrost lever.

The cabin heat selector, located in the center console, is used to regulate the flow of heated air.

Lever down = cabin heat FULL ON

The Floor/Defrost lever directs the heated air to the defrost and floor vents.

Lever down = all cabin heat to Floor

#### 7.4.3. Cabin Air

The cabin aeration is controlled by two adjustable air-vent nozzles. The two sliding windows in the canopy can be opened for additional ventilation.

## 7.5 LANDING GEAR SYSTEM

The landing gear system consists of the two main landing gear wheels mounted to aluminum spring struts and a 60° castering nose wheel. The suspension of the nose wheel is provided by an elastomer spring.

### 7.5.1. Wheel Brakes

Hydraulically operated disc brakes act on the wheels of the main landing gear. The wheel brakes are operated individually using the toe-brake pedals either on the pilot's or on the co-pilot's side. If either the left or right wheel brake system on the pilot's side fail, the co-pilot's brakes fail too. If the co-pilots brake master brake cylinder or input lines to the pilots master cylinder fails the pilots brakes will still operate.

### CAUTION

When placing the feet on the brake pedals, care should be taken to use only the toe of your shoe so you do not contact the structure above the pedals, which could prevent effective application of the brake(s).

### 7.5.2. Parking Brake

The Parking Brake knob is located on the center console in front of the throttle quadrant, and is pushed up when the brakes are to be released. To set the parking brake, pull the knob down to the stop. Repeated pushing of the toe-brake pedals will build up the required brake pressure, which will remain in effect until the parking brake is released.

To release the parking brake, push on the toe-brake pedals before releasing the parking brake knob.

### NOTE

When parking the aircraft for longer than 12 hours place wheel chocks in front of and behind the main landing gear wheels. Tie down ropes should also be used if you are uncertain of favorable climatic conditions for the duration of the park.

### Brake System Schematic

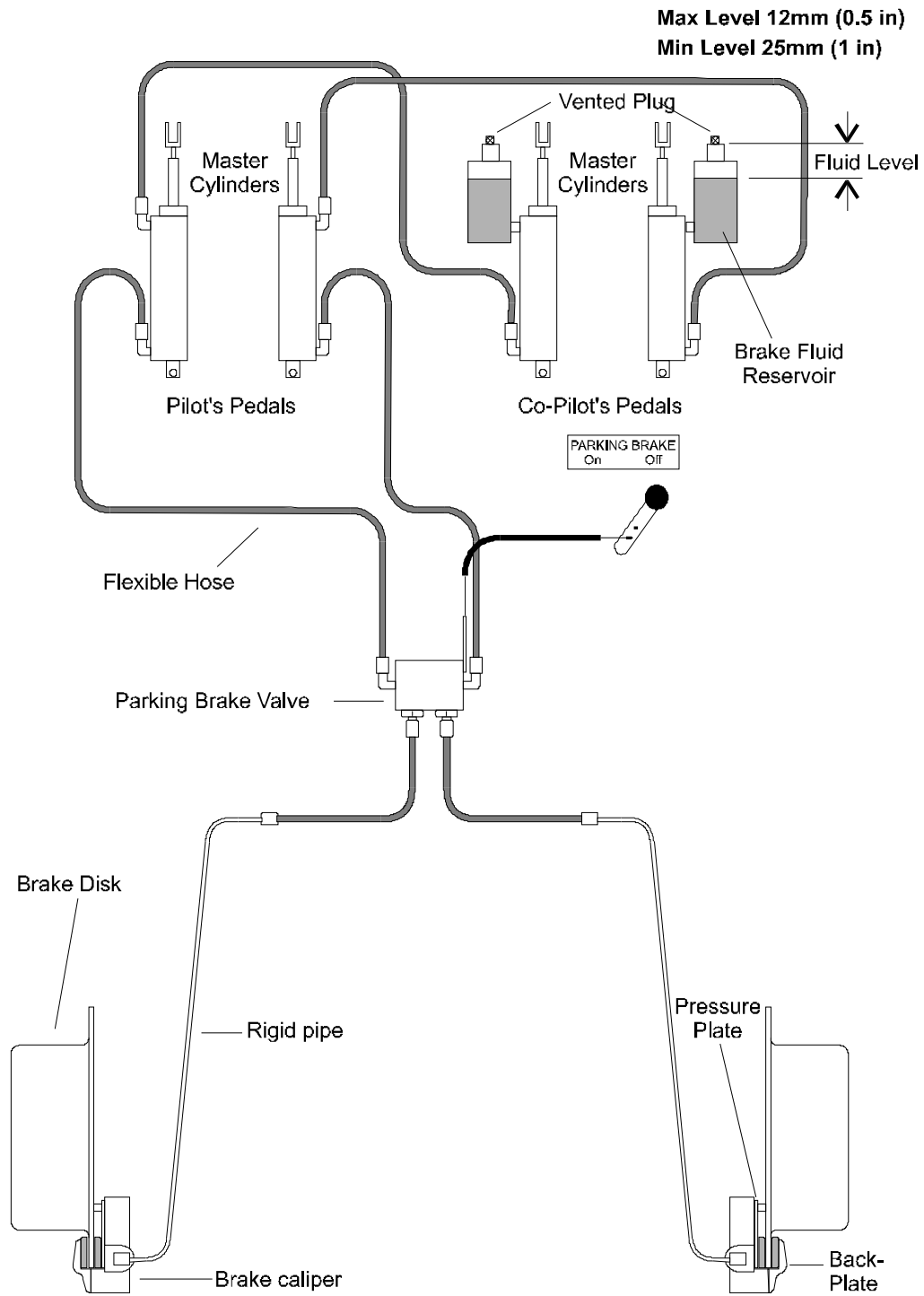

## 7.6 SEATS AND SAFETY BELTS

The seats are removable to facilitate the maintenance and inspection of the underlying controls. Covers on the control sticks prevent loose objects from entering the control area.

The seats have removable cushions.

Every seat is equipped with a four-point safety belt. To put on the safety belt, slip the lap belt through the shoulder belt-ends and insert the lap belt-end into the belt lock. Adjust the length of the belts so that the buckle is centered around your waist. Tighten the belts securely. The belt is opened by pulling the lock cover.

## 7.7 BAGGAGE COMPARTMENT

The baggage compartment is located behind the seat above the fuel tank. Baggage should be distributed evenly in the baggage compartment. The baggage net must be secured.

<b>CAUTION</b>
----------------

Ensure that baggage compartment limitations (44 lbs/20 kg max.) and aircraft weight and balance limitations are not exceeded.



## 7.8 CANOPY

### Locking:

The canopy is closed by pulling down on the forward handles on the canopy frame. Locking the canopy is accomplished by moving the two locking handles on the left and right side of the frame.

**To close:** Move both LH and RH locking handles forward.

**To open:** Move both LH and RH locking handles backwards.

A canopy locking warning light, located in the upper center section of the instrument panel, indicates the status of the canopy's locking mechanism. If the canopy locking warning light is illuminated, the canopy is not locked properly.

### CAUTION

Before starting the engine, the canopy must be closed and locked.

### NOTE

The Master Switch must be ON for the Canopy Locking Warning Light to be operational.

### NOTE

Some aircraft are equipped with external canopy locking handles. These do not affect operation of the inside locking handles.

## 7.9 POWERPLANT

### 7.9.1. Engine

DA20-C1 aircraft are equipped with the Continental IO-240-B engine. The IO-240-B is a fuel injected, 4 cylinder, 4 stroke engine with horizontally opposed, air cooled cylinders and heads. The propeller drive is direct from the crankshaft.

Displacement: 239.8 cu.in. (3.9 liters)  
 Max. Continuous Power: 125 HP / 93.25 kW at 2800 RPM

Additional information can be found in the Engine Operating Manual.

The powerplant instruments are located on the instrument panel on the co-pilot's side. The ignition switch is a key switch located on the instrument panel in front of the pilot. The ignition is turned on by turning the key to position BOTH. The starter is operated by turning the switch against the spring loaded start position. The engine is shut off by moving the mixture control to the idle cutoff position then turning the ignition switch to the off position.

The DA20-C1 may be equipped with an optional altitude compensating fuel pump. A placard on the instrument panel indicates if this system is installed. With this system it is not necessary to manually lean the mixture with altitude.

### 7.9.2. Engine Controls

The Mixture, Throttle and Alternate Air Control levers are grouped together in the center console. The tension/friction for the controls can be adjusted using the friction knob located on the right side of the center console.

**Mixture Lever:** right lever with red cylindrical handle and integral lock out lever  
 lever full forward = Full Rich  
 lever full aft = Idle Cutoff

The mixture control lever features a safety lock which prevents inadvertent leaning of the mixture. To release, squeeze the safety lock lever and the control knob together.

**Throttle:** center lever with "T" handle  
 lever full forward = FULL throttle  
 lever full aft = IDLE

**Alternate Air:** left lever with square handle  
 lever full forward = Primary air intake  
 lever full aft = Alternate air intake

The alternate air control selects a second induction air intake in case of restriction of the primary air intake (filter).

### 7.9.3. Mixture Control

#### (a) Cruise

The mixture control allows leaning of the fuel mixture to maximize fuel economy during cruise conditions. Teledyne Continental Motors specifies that above 75% of maximum rated power, the mixture must be set at **FULL RICH**. It should be noted that even with the throttle set at the full power position, actual power may be less than 75% of maximum rated power and then leaning is required (reference Section 5.3.2, Cruise performance).

#### (b) Reduced Throttle Settings

When operating at reduced throttle settings, other than steady state cruise, the mixture should always be set to **FULL RICH**. This applies to maneuvers (e.g.: stalls, spins, slow flight), descents, landing approaches, after landing and while taxiing.

The only exception to this is for engines without the altitude compensating fuel pump, operating at very high altitudes, where the low air density may require leaning to maintain satisfactory engine operation.

#### (c) Full Throttle

When operating at full throttle, the mixture must be set at **FULL RICH**. This applies to take-off, balked landings and climb.

The only exception is for engines without the altitude compensating fuel pump the mixture should be leaned as actual power falls below 75% of maximum rated power, as may be the case in an extended climb (reference Section 5.3.2, Cruise performance).

<b>NOTE</b>
-------------

All adjustment of the mixture control should be done in small increments.

### 7.9.4. Propeller

The propeller is either a fixed pitch Hoffmann composite wood and glass fiber propeller or a fixed pitch Sensenich wood propeller.

**7.9.7. Lubricating**

The engine has a high pressure wet sump lubrication. The oil is pumped by a mechanical, engine driven pump. An oil dipstick indicates the level of oil in the tank. The dipstick is marked for US quarts.

**CAUTION**

Never operate the engine with the oil filler cap removed.  
Observe normal procedures and limitations while running engine.

With the engine stopped, check the oil level on the dipstick. The oil level must be between the 6 US quart and 4 US quart level as indicated by the markings on the dip stick.

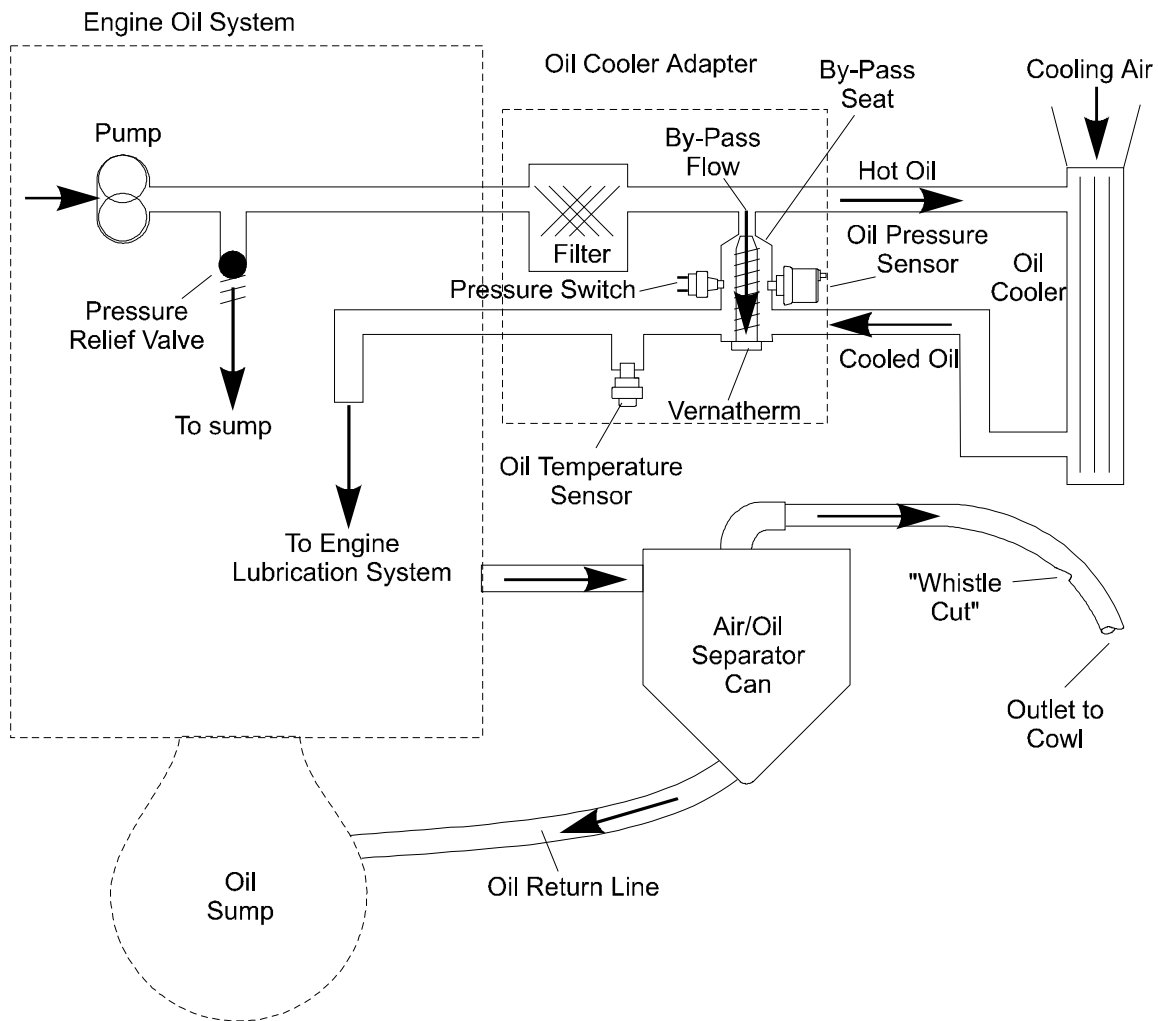

## 7.10 FUEL SYSTEM

The aluminum tank is located behind the seats, below the baggage compartment. The capacity is specified in Section 2 of this manual. The tank filler on the left side of the fuselage behind the canopy is connected to the tank with a rubber hose. A grounding stud is located on the under side of the fuselage near the trailing edge of the left hand wing. The aircraft must be grounded prior to any fueling operation. The tank vent line runs from the filler neck through the fuselage bottom skin to the exterior of the airplane. The vent line is the translucent plastic hose adjacent to the left wing root. The vent line must be clear for proper fuel system operation. The tank has an integral sump which must be drained prior to each flight, by pushing up on the brass tube which protrudes through the underside of the fuselage, forward of the trailing edge of the left hand wing.

Two outlets with finger filters, one left and one right, are installed at the bottom of the tank. Fuel is gravity fed from these outlets to a filter bowl (gascolator) and then to the electric fuel pump. The filter bowl must be drained prior to each flight, by pushing up on the black rubber tube that protrudes through the underside of the fuselage, adjacent to the fuel tank drain. The electric fuel pump primes the engine for engine starting (Prime ON) and is used for low throttle operations (Fuel Pump ON). When the pump is OFF, fuel flows through the pump's internal bypass. From the electric pump, fuel is delivered to the engine's mechanical fuel pump by the fuel supply line. Fuel is metered by the fuel control unit and flows via the fuel distribution manifold to the injector nozzles.

Closing the fuel shut-off valve, located either on the aft side of the firewall or at the maintenance drain manifold, will cause the engine to stop within a few seconds.

A return line from the mechanical pump's fuel vapor separator returns vapor and excess fuel to the tank. Fuel pressure is measured at the fuel distribution manifold and displayed on the fuel pressure indicator, which is calibrated in PSI.

Some DA20-C1 aircraft also have a fuel vapor separator in the distribution manifold. These aircraft have a second vapor return line from the distribution manifold to the firewall.

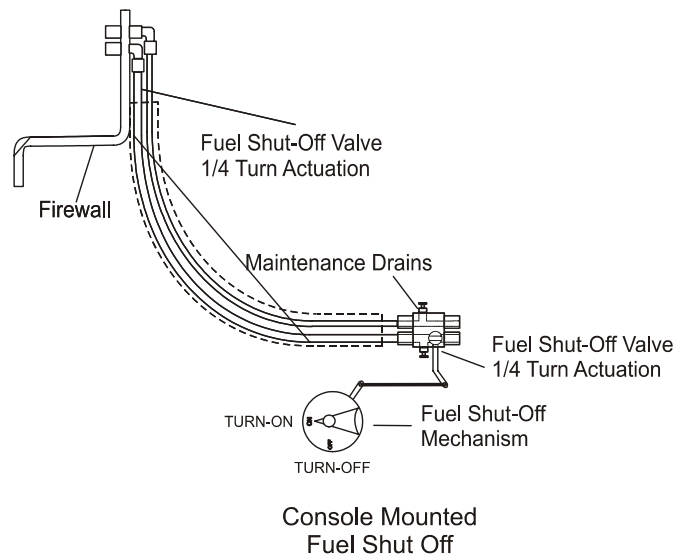
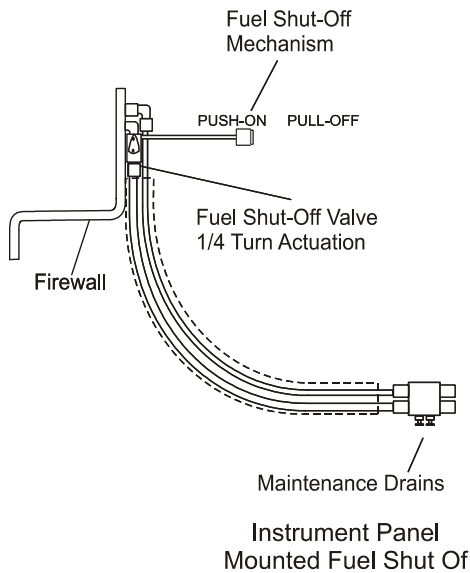
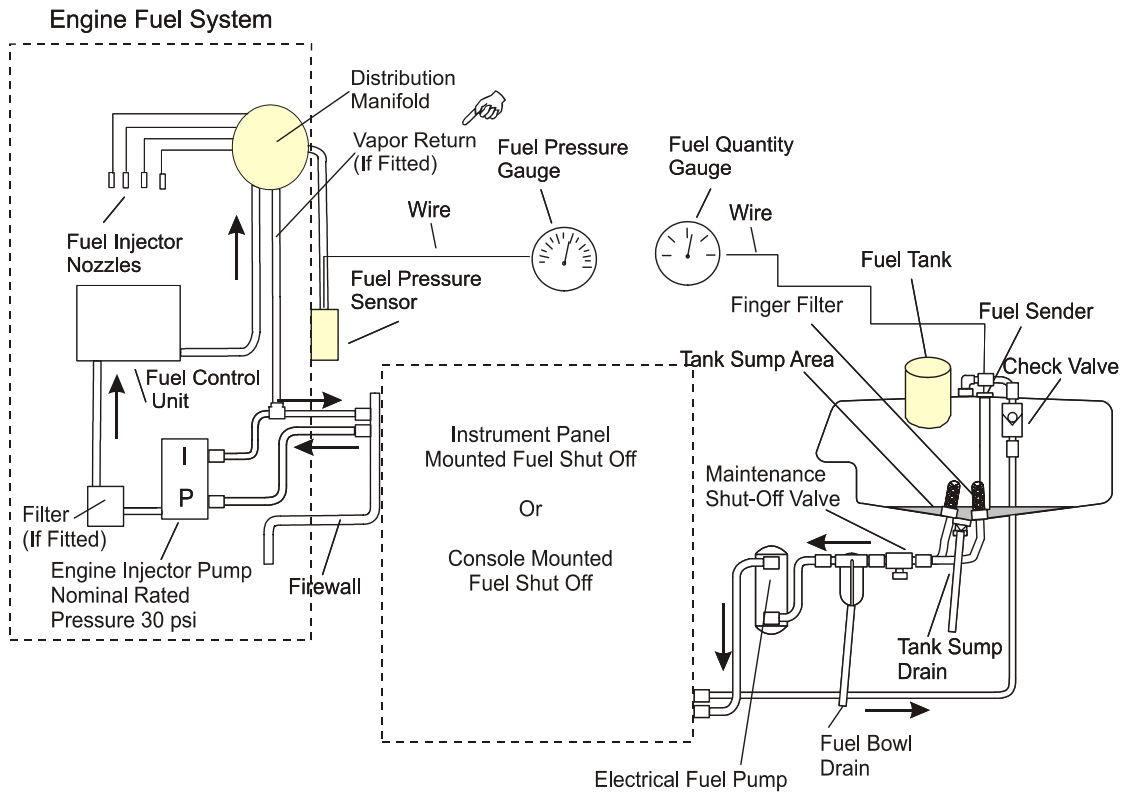

### 7.10.1. Fuel Shut-off Valve

#### **WARNING**

The fuel shut-off valve should only be closed for emergencies or fuel system maintenance.

There are two different versions of fuel shut-off valves in the DA20-C1.

#### Version 1

The fuel shut-off valve is located on the cabin side of the firewall and is controlled by a handle on the right side center pedestal. To activate the fuel shutoff valve, lift the handle release lock and pull the handle out. In the open position the knob is in. In the closed position the knob is out.

#### Version 2

The fuel shut-off valve is integral to the maintenance drain manifold, located below the fuel tank. It is actuated by the center console mounted rotary lever, via a rigid pushrod. To activate the valve, rotate the lever clockwise from OFF to ON or lift the lockout knob and rotate the lever counterclockwise from ON to OFF. The safety lockout knob prevents accidental actuation of the valve.

### 7.10.2. Tank Drain

To drain the tank sump, activate the spring loaded drain by pushing the brass tube in with a drain container. The brass tube protrudes approx. 1 1/6 in (30 mm) from the fuselage contour and is located on the left side of the fuselage, approximately at the same station as the fuel filler cap.

### 7.10.3. Fuel Filter Bowl

The fuel filter bowl is between the tank and the fuel pump. The bowl acts as a trap for sediment and water that has entered the fuel line from the tank.

### 7.10.4. Fuel Filter Bowl Drain

The filter bowl drain is next to the fuel tank drain. It operates in the same manner as the fuel tank drain.

### 7.10.5. Fuel Dipstick

A fuel dipstick, P/N 22-2550-14-00, is supplied with all aircraft to permit direct measurement of fuel level during the preflight check. On serial numbers C0056, C0066, C0067 and C0069 use fuel dipstick P/N 22-2550-17-00.

#### **NOTE**

Electric fuel gauges may malfunction. Check fuel quantity with fuel dipstick before each flight.

To check the fuel level:

1. Insert the graduated end of the fuel dipstick into the tank through the fuel filler opening until the dipstick touches the bottom.
2. Withdraw the dipstick from the fuel tank.
3. Read fuel quantity. The dipstick is calibrated in increments of  $\frac{1}{4}$  of useable fuel capacity. (21.3 US gallons/80.5 liters for Type 1 Fuel System or 24.0 US gallons/91 liters for Type 2 Fuel System).

**NOTE**

Several readings should be taken to confirm accuracy.

**7.10.6. Electric Fuel Pump (Priming Pump) Operation**

The DA20-C1 is equipped with a DUKES constant flow, vane type, two speed, electric fuel pump. This pump emits an audible whine when it is switched on.

**I. Fuel Prime**

The pump's high speed setting is used for priming the engine prior to engine start. The prime setting is selected by turning the FUEL PRIME switch ON. An amber annunciator indicates that FUEL PRIME ON is selected.

**II. Fuel Pump**

The pump's low speed setting is required for maintaining positive fuel supply system pressures at low throttle settings. This setting is selected by turning the FUEL PUMP switch ON. This setting should be selected for any low throttle operations, including taxiing and any flight operations when engine speed may fall below 1000 RPM (eg. stalls, spins, descents, landings, etc.). The FUEL PUMP may also be **selected ON to suppress suspected vapour formation in the fuel supply system. Smooth engine operation at high ambient temperatures with heat soaked fuel and up to and exceeding the service ceiling has been demonstrated without use of the electric pump.**

**NOTE**

Turning the priming pump on while the engine is running, will enrichen the mixture considerably. Although the effect is less noticeable at high power settings when the fuel flow rate is high, the effect at low and idle throttle settings is an overrich mixture, which may cause rough engine operation or engine stoppage. **It is therefore recommended that for normal operations, the FUEL PRIME be turned OFF.**



## 7.11 ELECTRICAL SYSTEM

### 7.11.1. Power Supply

A 12 V battery is connected to the master bus via the battery circuit breaker (50 Amps). The 40 amp. generator is attached to the engine near the propeller hub. The generator feeds the main bus via the generator circuit breaker (50 Amps). Both circuit breakers can be triggered manually. The generator warning light is activated by an internal voltage regulator monitoring circuit and illuminates when a generator fault occurs .

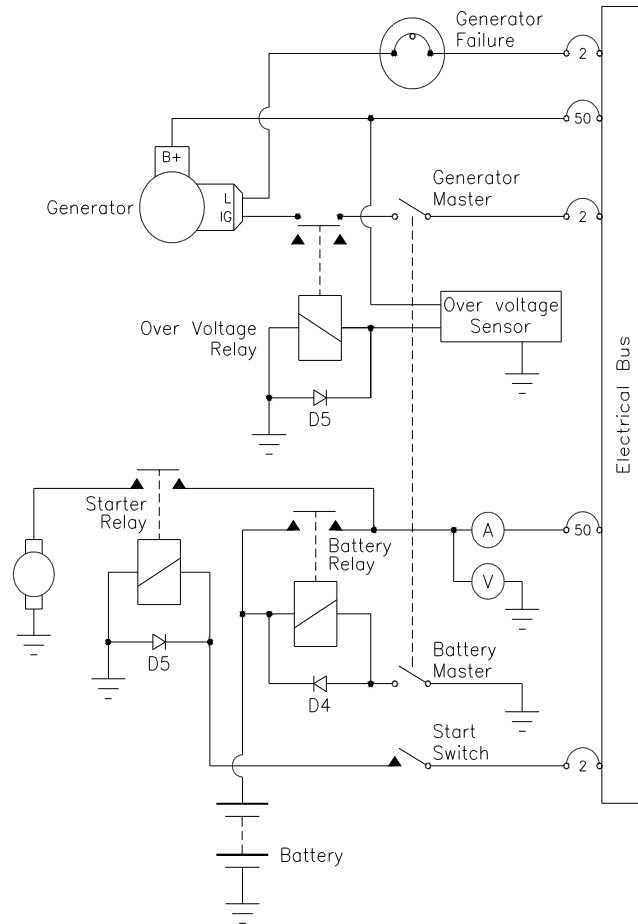

Simplified Schematic

### 7.11.2. Ignition System

The engine is provided with two independent ignition systems. The two magnetos are independent from the power supply system, and are in operation as soon as the propeller is turning and the ignition switch is not off. This ensures safe engine operation even in case of an electrical power failure.

## WARNING

If the ignition key is turned to L, R or BOTH, the respective magneto is "HOT". If the propeller is moved during this time the engine may start and cause serious or fatal injury to personnel. The possibility of a 'HOT' magneto may exist due to a faulty switch or aircraft wiring. Use EXTREME CARE and RESPECT when in the vicinity of a propeller!

### 7.11.3. Electrical Powered Equipment

The individual consumers (e.g. Radio, Fuel Pump, Position Lights, etc.) are connected in series with their respective circuit breakers. Refer to Section 7.4 for a illustration of the instrument panel.

### 7.11.4. Voltmeter

The voltmeter indicates the status of the electrical bus. It consists of a dial that is marked numerically from 8 - 16 volts in divisions of 2.

The scale is divided into three colored arcs to indicate the seriousness of the bus condition. These arcs are:

Red	for 8.0 - 11.0 volts,
Yellow	for 11.0 - 12.5 volts,
Green	for 12.5 - 16.0 volts,
Redline	at 16.1 volts.

### 7.11.5. Ammeter

The ammeter indicates the charging (+) and discharging (-) of the battery. It consists of a dial, which is marked numerically from -60 to 60 amps.

### 7.11.6. Generator Warning Light

The generator warning light (red) illuminates during:

- Generator failure, no output from the generator

The only remaining power source is the battery (20 amps. for 30 minutes)

### 7.11.7. Instruments

The instruments for temperatures, pressures, and fuel quantity are connected to their respective sensors. When the electrical resistance of a sensor changes it causes a corresponding change (needle deflection) in its respective indicator.

**7.11.8. Internal Lighting**

The internal lighting of the DA 20-C1 is provided by a lighting module located aft of the Pilot's head and on the centerline of the aircraft. Included in this module are two panel illumination lights and one map light. The switches for the lights are located on the instrument panel. There is a dimming control located on the left side of the instrument panel for adjusting the intensity of the lighting. There is a toggle switch located beside the dimming control that controls the intensity of the Wing Flap and Trim Annunciator.

**Illumination Pattern and Adjustment**

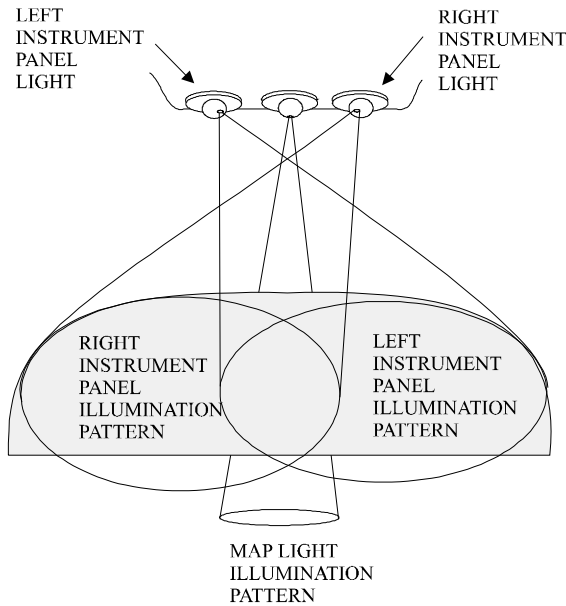

Care must be taken when adjusting the lights to maintain proper illumination. The Illumination Pattern and Adjustment shows how the lights are aimed in order to provide proper panel illumination.

Aircraft equipped with supplemental lighting (MOD 32) have a Light Dimmer Module and a Glare Shield mounted Flood Light. Control of the Dimmer for backlit instruments is through the Instrument lighting potentiometer. Control of the flood light is through a potentiometer marked FLOOD.

- 1. ROTATE BALL TO CHANGE ELIPSE ANGLE

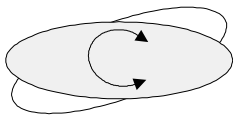

- 2. ADJUST VERTICAL POSITION

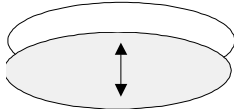

- 3. ADJUST HORIZONTAL POSITION

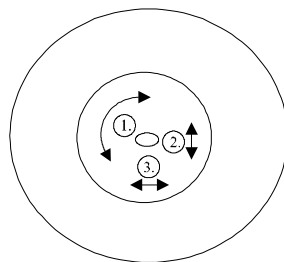
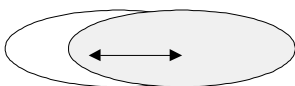

Ball Light

## 7.12 PITOT AND STATIC PRESSURE SYSTEMS

The pitot pressure is measured on the leading edge of a calibrated probe below the left wing. The static pressure is measured by the same probe. For protection against water and humidity, water sumps are installed within the line. These water sumps are accessible beneath the left seat shell.

The error in the static pressure system is negligible. For the error of the airspeed indicating system refer to Chapter 5.

The pitot static pressure probe should be protected whenever the aircraft is parked to prevent contamination and subsequent malfunction of the aircraft systems relying on its proper functioning.

### NOTE

Use only the factory supplied pitot static probe cover, P/N G-659-200 with the “Remove before Flight” flag attached.

## 7.13 STALL WARNING SYSTEM

When the airspeed drops below 1.1 times the stall speed, a horn sounds in the left instrument panel. The horn grows louder as the speed approaches the stall speed. The horn is activated by air from a suction hose that connects to a hole in the leading edge of the left wing. The hole has a red circle around it.

The stall warning hole should be plugged whenever the aircraft is parked to prevent contamination and subsequent malfunction of the stall warning system.

### NOTE

Use only the factory supplied stall warning plug, P/N 22-1010-01-00 with the “Remove before Flight” flag attached.

## 7.14 AVIONICS

The center of the instrument panel contains the radio and navigation equipment. The microphone key for the radio is installed in the control stick. There are two connectors for headsets on the backrest of the seat.

Operating instructions for individual avionics equipment should be taken from the manuals of the respective manufacturers.

---

## CHAPTER 8

# HANDLING, PREVENTIVE AND CORRECTIVE MAINTENANCE

<b>8.1</b>	<b>INTRODUCTION</b>	<b>8-2</b>
<b>8.2</b>	<b>AIRPLANE INSPECTION PERIODS</b>	<b>8-2</b>
<b>8.3</b>	<b>AIRPLANE ALTERATIONS OR REPAIRS</b>	<b>8-2</b>
<b>8.4</b>	<b>GROUND HANDLING / ROAD TRANSPORT</b>	
<b>8.4.1</b>	<b>Ground Handling</b>	<b>8-3</b>
<b>8.4.2</b>	<b>Parking</b>	<b>8-4</b>
<b>8.4.3</b>	<b>Mooring</b>	<b>8-4</b>
<b>8.4.4</b>	<b>Jacking</b>	<b>8-4</b>
<b>8.4.5</b>	<b>Road Transport</b>	<b>8-5</b>
<b>8.5</b>	<b>CLEANING AND CARE</b>	
<b>8.5.1</b>	<b>Painted Exterior Surfaces</b>	<b>8-6</b>
<b>8.5.2</b>	<b>Canopy</b>	<b>8-6</b>
<b>8.5.3</b>	<b>Propeller</b>	<b>8-7</b>
<b>8.5.4</b>	<b>Engine</b>	<b>8-7</b>
<b>8.5.5</b>	<b>Interior Surfaces, Seats and Carpets</b>	<b>8-7</b>

## 8.1. INTRODUCTION

This Chapter contains factory-recommended procedures for proper ground handling and servicing of the airplane. It also identifies certain inspection and maintenance requirements which must be followed if the airplane is to retain its' original performance and dependability. It is wise to follow a planned schedule of lubrication and preventive maintenance based on climatic and flying conditions encountered.

## 8.2. AIRPLANE INSPECTION PERIOD

Inspection intervals are every 50, 100 hrs, 200 hrs and 1000 hrs of flight time and a special 25 hour check on new airplanes. The respective maintenance procedure can be found in the Engine Manual or the Airplane Maintenance Manual.

## 8.3. AIRPLANE ALTERATIONS OR REPAIRS

It is essential that the responsible airworthiness authority be contacted prior to any alterations on the airplane to ensure that the airworthiness of the airplane is not affected. For repairs and painting refer to the applicable Maintenance Manual Doc. No. DA201-C1.

## 8.4. GROUND HANDLING / ROAD TRANSPORT

### 8.4.1. Ground Handling

#### I. Towing Forward

The airplane is most easily and safely maneuvered by hand with the tow-bar attached to the nose wheel. If the aircraft is towed forward without using the tow-bar, the nose-wheel will follow the movement of the airplane. It is recommended that the tow-bar be used to pull the aircraft forward. If any additional assistance is required, the DA 20 may only be pushed on the trailing edge of the wing tip.

#### II. Moving Backward

By following a simple procedure it is very easy to move the airplane backwards.

1. Push down with one hand on the aft section of the fuselage near the vertical stabilizer, to lift the nose wheel.
2. Push back on the leading edge of the horizontal stabilizer, close to its center.

Using this technique the DA 20 be turned and pushed backward. If additional assistance is required, a second person may push on the leading edge of the wings.

**CAUTION**

Do not push or lift on Spinner!

**CAUTION**

Do not push on control surfaces!

#### 8.4.2. Parking

For short time parking, the airplane must be positioned in a headwind direction, the parking brake must be engaged, the wing flaps must be in the retracted position and the wheels must be chocked.

For extended and unattended parking, as well as in unpredictable wind conditions, the airplane must be anchored to the ground or placed in a hangar.

When parking the airplane, the flight controls lock, P/N 20-1000-01-00 must be installed and pitot static probe cover and stall warning plug should be fitted (ref. Chapter 7, Aircraft Description).

Parking in a hangar is recommended.

#### 8.4.3. Mooring

The tail skid of the airplane has a tie down hole which can be used to moor airplane. Tie-down rings are also installed near the midpoint on each wing for tie-down mooring ropes.

#### 8.4.4. Jacking

The DA 20 can be jacked at the two jackpoints located on the lower side of the fuselage's root ribs and at the tail fin.



#### 8.4.5. Road Transport

When transporting the airplane on the road, it is recommended that you use an open trailer. All airplane components must be stored on a cushioned surface and secured to avoid any movement during transport.

**(a) Fuselage:**

The fuselage should be secured on the trailer standing on its wheels. Ensure that the propeller has sufficient free space so it cannot be damaged if the fuselage were to move.

**(b) Wings:**

For transportation, both wings must be removed from the fuselage.

To avoid any damage, the wings are stored in upright position on the leading edge with the root rib area positioned on an upholstered profiled surface of at least 1 ft 4 in (400 mm) width. The outside wing area (approximately 10 ft (3 m) from the root rib area) is placed on an upholstered profiled surface of a minimum of 12 in (300 mm) width.

The wings must be secured against movement rearward or forward.

**(c) Horizontal Stabilizer:**

The horizontal stabilizer is stored flat on the trailer and secured, or in an upright position sitting on the leading edge on a profiled surface. All supports must be upholstered with felt or foam rubber.

## 8.5. CLEANING AND CARE

### CAUTION

Excessive dirt deteriorates the flight performance.

#### 8.5.1. Painted Surfaces

To achieve the best flight characteristics for the DA20, a clean external surface is most important. For this reason it is highly recommended that the airplane, especially the leading edge of the wings are kept clean at all times.

For best results, the cleaning is performed using a generous amount of water. If necessary, a mild cleaning agent can be added. Excessive dirt such as insects etc. are best cleaned off immediately after flight, because once dried they are difficult to remove.

Approximately once a year, the surface of the airplane should be treated and buffed using a silicon free automotive polish.

### CAUTION

DO NOT use any cleaning agents containing silicon based materials. Once applied, silicone is difficult to remove. Silicone may result in contaminated bonding surfaces if the aircraft were ever in need of structural repair.

#### 8.5.2. Canopy

The DA 20 offers excellent vision through a large plexiglass canopy. It is essential that care be taken while cleaning the canopy, as it is easily scratched. If scratched, the vision will be reduced.

In principal the same rules should be applied to clean the canopy as for the outside surface of the airplane. To remove excessive dirt, plenty of water should be used; make sure to use only clean sponges and chamois. Even the smallest dust particle can cause scratches.

In order to achieve clarity, plastic cleaners such as Permatex Part No. 403D<sup>®</sup> or Mirror Glaze<sup>®</sup> may be used according to the manufacturer's instructions. Do not wipe in circles, but only in one direction.

**8.5.3. Propeller**

See Hoffmann Propeller Instruction Manual E 0110.74.

**8.5.4. Engine**

See Operator's Manual for the Continental IO 240B aircraft engine Form # X30620.

**8.5.5. Interior Surfaces, Seats and Carpets**

The interior should be cleaned using a vacuum cleaner. All loose items (pens, bags etc.) should be properly stored and secured. All instruments can be cleaned using a soft dry cloth, plastic surfaces should be wiped clean using a damp cloth without any cleaning agents.

## CHAPTER 9

# SUPPLEMENTS

<b>9.1</b>	<b>GENERAL</b>	<b>9-1</b>
<b>9.1</b>	<b>INDEX OF SUPPLEMENTS</b>	<b>9-2</b>

### 9.1 GENERAL

This Chapter contains information regarding optional equipment which may be installed in your airplane. Individual supplements address each optional equipment installation. It is only necessary to maintain those supplements which pertain to your specific airplane's configuration.

## 9.2 INDEX OF SUPPLEMENTS

### NOTE

It is only necessary to maintain those supplements which pertain to optional equipment that may be installed in your airplane.

<b>Supplement No.</b>	<b>Title</b>	<b>Pages</b>
1	External Power Operation	9
2	Winterization Kit	3
3	Recognition Lights	4
4	Gross Weight Increase (800 Kg)	15
5	S-Tec Autopilot	10
6	VM1000 Engine Instruments	7
7	Auxiliary Fuel System	6
8	Stick Mounted Trim Switches	3
9	20 US Gallon Fuel Tank	3
10	Reversed Instrument Panel	3
11	Pitot Heat Operation	5

--	--	--

CHAPTER 9  
SUPPLEMENT 1  
**EXTERNAL POWER OPERATION**

1	GENERAL	S1-2
2	OPERATING LIMITATIONS	S1-3
3	EMERGENCY PROCEDURES	S1-4
4	NORMAL PROCEDURES	S1-4
5	PERFORMANCE	S1-9
6	WEIGHT AND BALANCE	S1-9

## 1. GENERAL

This supplement addresses the operating procedure for a DA20-C1 aircraft equipped with an optional External Power Unit (EPU). The EPU receptacle and related circuits provide for the connection of an external power source for various ground operations, eg. maintenance, battery charging, starting.

### CAUTION

Over-voltage protection does not exist. **DO NOT** connect any power source other than 12 volt DC battery or 14 volt (nominal) DC Ground Power Cart.

The circuit provides protection in the event that the external power source is connected in reverse polarity. A switch in the cockpit to the left of the light switches allows the EPU relay to close once the external power source is connected and power is available. A light in the cockpit indicates that power is available at the receptacle or that the EPU relay has remained closed following a disconnect (see normal procedures).

On aircraft C0001 through C0148 and C0150 with an EPU installed, a relay bypass circuit is provided to enable the battery relay to be closed if the battery has been discharged so much that it does not have enough power to close the relay by itself. Depending on the state of battery discharge, the battery relay may take several minutes to close. This circuit is not installed on aircraft C0149 and C0151 onwards. See fig 1.1 for location and figure 1.2 for simplified schematic. EPU plug Cole Hersee **P/N 11042** is required to connect to the receptacle. This receptacle is located in one of two locations. Aircraft serial numbers C0001 through C0148 and C0150 have this receptacle located on the fuselage at the rear portion of the wing root. Aircraft serial numbers C0149 and C0151 onwards have this receptacle located on the fuselage in front of the left-hand wing root.

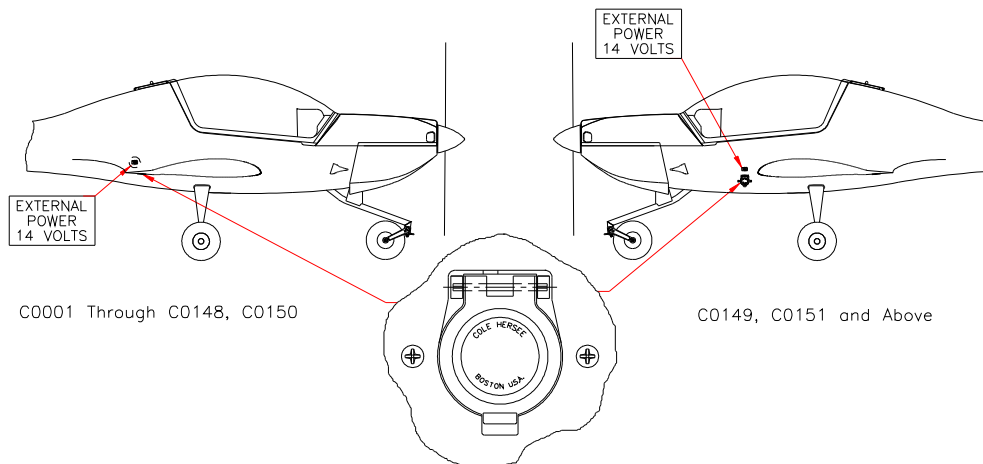

**Figure 1.1**



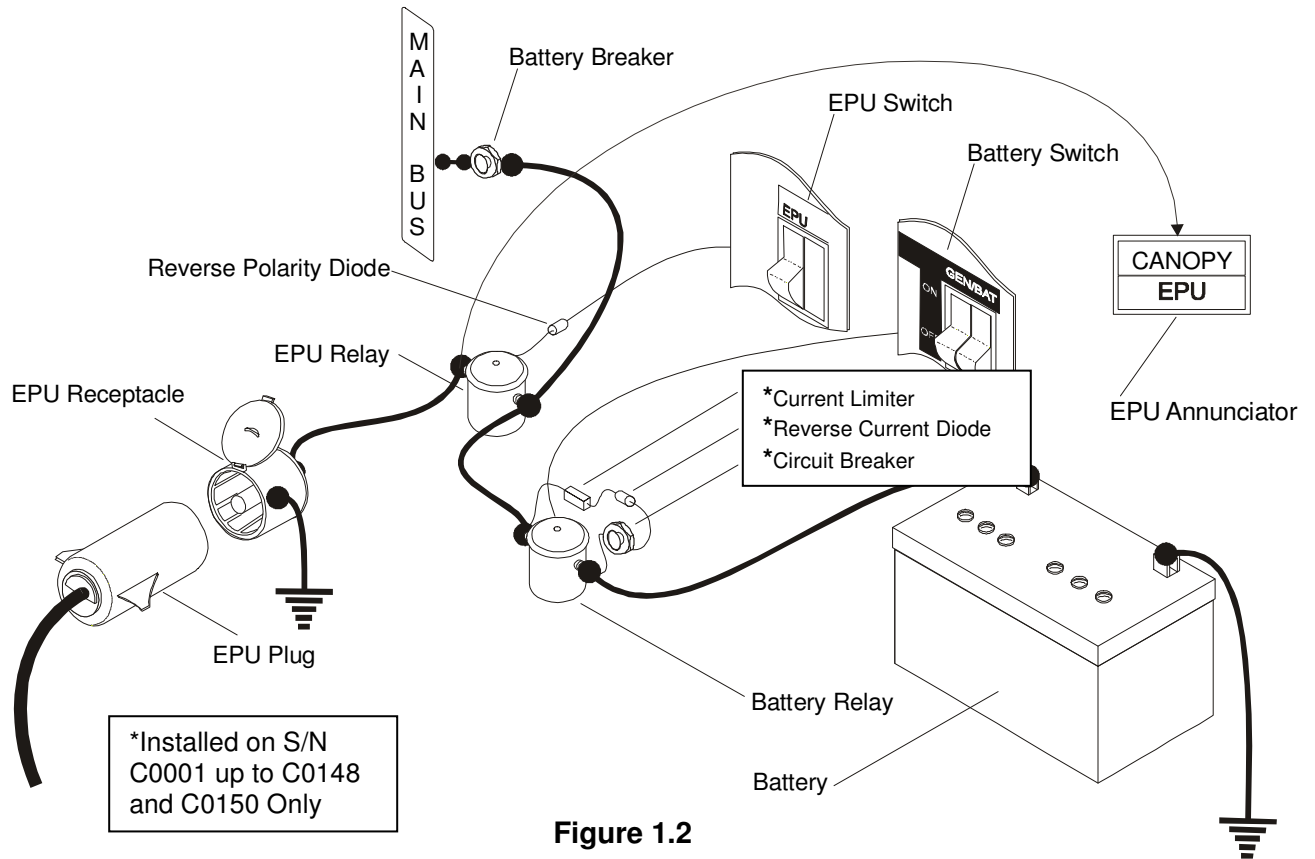

Figure 1.2

### OPERATING LIMITATIONS

2.1. Voltage supplied to the EPU receptacle should be **12-14 volts** nominal.

### PLACARDS

1. On the lower left side of instrument panel above the switches.

2. On the right side of the aircraft above the EPU receptacle.

3. On the EPU/Fuse mounting bracket in the Relay Box. (Aircraft S/N C0001 through C0148 and C0150 only)

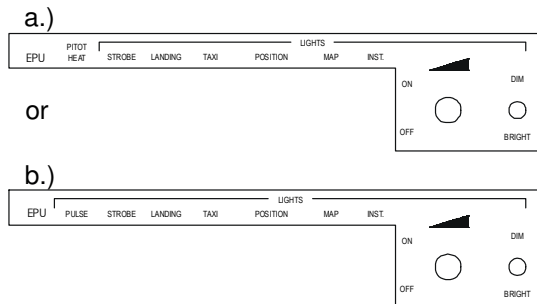

EXTERNAL  
POWER  
14 VOLTS

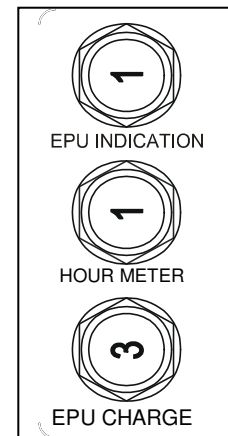

### 3. EMERGENCY PROCEDURES

#### 3.3.4 FIRE

(a) **Engine Fire during Engine-Start-Up on the Ground (EPU power connected).**

- |    |                               |             |
|----|-------------------------------|-------------|
| 1. | Fuel Shut-off Valve           | CLOSED      |
| 2. | Cabin Heat                    | CLOSED      |
| 3. | Mixture                       | IDLE CUTOFF |
| 4. | Throttle                      | FULL        |
| 5. | GEN/BAT Master Switch         | OFF         |
| 6. | Ignition Switch               | OFF         |
| 7. | <b>EPU Switch</b>             | <b>OFF</b>  |
| 8. | Evacuate Airplane immediately |             |

### 4. NORMAL PROCEDURES

#### 4.4.0 General

The following general procedure should be used to supply External Power to the aircraft for purposes other than engine starting.

##### Power ON

- |    |  |                            |
|----|--|----------------------------|
| 1. | Connect external power source to the EPU receptacle. | EPU light ON               |
| 2. | EPU switch   | ON                         |
| 3. | GEN/BAT Master Switch (Battery only)                 | ON if desired for charging |
| 4. | Avionics Master Switch                               | ON if desired              |

<b>CAUTION</b>
----------------

If the battery has been discharged, it is advisable to leave the battery on charge for a period of time long enough to charge the battery. Consult maintenance personnel if the state of charge of the battery is in question. Do not fly the aircraft with the battery in a discharged state.

##### Power OFF

- |    |  |               |
|----|--|---------------|
| 1. | Electrical loads                                     | OFF           |
| 2. | Avionics Master Switch                               | OFF           |
| 3. | GEN/ BAT Master Switch                               | OFF           |
| 4. | EPU switch   | OFF           |
| 5. | LIFT EPU receptacle cover, PULL external power plug. | EPU light OFF |

## 4.4.1 NORMAL OPERATION CHECKLIST

In addition to those items contained in Section 4, Normal Operating Procedures, Preflight Inspection, check the following items if this supplement is applicable to the aircraft you are operating:

### I. In-Cabin Check

Caution Lights (EPU) illuminated if EPU power available

### II. Walk Around Check and Visual Inspection

#### Right Wing (C0001 to C0148, C0150)

#### Left Side of Fuselage (C0149, C0151 and Above)

EPU Receptacle ( For EPU START)	check EPU connector inserted and secure. Adequate power source available.
EPU Receptacle (EPU not required for starting)	check EPU power cord disconnected and power cart clear of aircraft.

### Before Starting Engine

The Before Starting Engine checklist from section 4.4.2 is repeated in this section and includes the steps for starting the engine with an external power source connected.

### 4.4.2. Before Starting Engine

- |            |                                      |                          |
|------------|--------------------------------------|--------------------------|
| 1.         | Preflight Inspection                 | performed                |
| 2.         | Pedals                               | adjust, lock             |
| 3.         | Passenger Briefing                   | performed                |
| 4.         | Safety Belts                         | fasten                   |
| 5.         | Parking Brake                        | set                      |
| 6.         | Flight Controls                      | free                     |
| 7.         | Fuel Shut-off Valve                  | OPEN                     |
| 8.         | Mixture                              | FULL RICH                |
| 9.         | Throttle                             | IDLE                     |
| 10.        | Friction Device of Throttle Quadrant | adjust                   |
| 11.        | Avionics Master Switch               | OFF                      |
| <b>12.</b> | <b>EPU light</b>                     | <b>check ON</b>          |
| <b>13.</b> | <b>EPU Switch</b>                    | <b>ON</b>                |
| <b>14.</b> | <b>Voltmeter</b>                     | <b>check 12-14 volts</b> |

- |     |                                |                  |
|-----|--------------------------------|------------------|
| 15. | GEN/BAT Master Switch          | ON               |
| 16. | Generator Warning Light        | illuminated      |
| 17. | Exterior Lights                | as required      |
| 18. | Instrument Panel Lighting      | as required      |
| 19. | Canopy                         | close and secure |
| 20. | Canopy Unlocking Warning Light | OFF              |

**Starting Engine**

The Starting Engine checklist from section 4.4.3 is repeated in this section and includes the steps for starting the engine with an external power source connected.

**4.4.3. Starting Engine**

**(a) Starting Engine Cold**

**NOTE**

It is recommended that the engine be preheated if it has been cold soaked for 2 hours or more at temperatures of -4°C (25°F) or less.

- |    |                |           |
|----|----------------|-----------|
| 1. | Throttle       | IDLE      |
| 2. | Mixture        | FULL RICH |
| 3. | Toe Brakes     | hold      |
| 4. | Propeller Area | clear     |

**WARNING**

Ensure that propeller area is clear!

**CAUTION**

Do not engage starter if propeller is moving. Serious engine damage can result

**NOTE**

Steps 5, 6, 7, 8 and 9 are to be performed without delay between steps.

**NOTE**

Colder ambient temperatures require longer priming

- |    |            |    |
|----|------------|----|
| 5. | Fuel Pump  | ON |
| 6. | Fuel Prime | ON |

- |     |                       |   |
|-----|-----------------------|---|
| 7.  | Throttle              | FULL for prime<br>(prime for 3 seconds minimum before starting)   |
| 8.  | Throttle              | Full IDLE to ¼ inch OPEN as required  |
| 9.  | Ignition Switch       | START, hold until engine starts or for 10 seconds maximum<br>(if engine does not start, release ignition key, then push throttle to full power for 3 seconds minimum for more priming, then repeat from Step 8) |
| 10. | Starter Warning Light | illuminated while ignition is in START position   |

<b>NOTE</b>
-------------

Activate starter for maximum of 30 seconds only,  
followed by a cooling period of 3-5 minutes

- |     |          |                 |
|-----|----------|-----------------|
| 11. | Throttle | 800 to 1000 RPM |
|-----|----------|-----------------|

<b>CAUTION</b>
----------------

Do not operate engine above 1000 RPM until  
an oil temperature indication is registered.

- |     |                    |       |
|-----|--------------------|-------|
| 12. | Fuel Prime         | OFF   |
| 13. | Engine Instruments | check |

<b>NOTE</b>
-------------

Excessive priming can result in a flooded engine. To clear a flooded engine, turn off fuel pump and fuel prime, open throttle ½ - 1 inch and engage starter. The engine should start for a short period and then stop. Excess fuel has now been cleared and engine start from item 1 can be performed.

<b>CAUTION</b>
----------------

If oil pressure is below 10 psi, shut down engine immediately (maximum 30 seconds delay).

<b>NOTE</b>
-------------

Oil Pressure may advance above the green arc until Oil Temp. reaches normal operating temperatures.

Regulate warm up RPM to maintain pressure below 100 psi limit. At ambient temperatures below 32°F (0°C) **DO NOT** apply full power if oil pressure is above 70 psi.

- |     |                       |           |
|-----|-----------------------|-----------|
| 14. | Starter Warning Light | check OFF |
|-----|-----------------------|-----------|

**(b) Starting Engine Warm**

- |    |                |           |
|----|----------------|-----------|
| 1. | Throttle       | IDLE      |
| 2. | Mixture        | FULL RICH |
| 3. | Toe Brakes     | hold      |
| 4. | Propeller Area | clear     |

**WARNING**

Ensure that propeller area is clear!

**CAUTION**

Do not engage starter if the propeller is moving. Serious damage can result.

**NOTE**

Steps 5, 6, 7, 8 and 9 are to be performed without delay between steps.

- |     |                       |   |
|-----|-----------------------|---|
| 5.  | Fuel Pump             | ON  |
| 6.  | Fuel Prime            | ON  |
| 7.  | Throttle              | Full for prime, 1 to 3 seconds before starting  |
| 8.  | Throttle              | ½ - 1 inch OPEN (approximately)   |
| 9.  | Ignition Switch       | START, hold until engine starts or for 10 seconds maximum (repeat from Step 7 if engine does not start) |
| 10. | Starter Warning Light | illuminated while ignition is in START position   |

**NOTE**

Activate starter for maximum of 30 seconds only, followed by a cooling period of 3-5 minutes.

- |     |                    |                 |
|-----|--------------------|-----------------|
| 11. | Throttle           | 800 to 1000 RPM |
| 12. | Fuel Prime         | OFF             |
| 13. | Engine Instruments | check           |

**NOTE**

Excessive priming can result in a flooded engine. To clear a flooded engine, turn off fuel pump and fuel prime, open throttle ½ - 1 inch and engage starter. The engine should start for a short period and then stop. Excess fuel has now been cleared and engine start from item 1 can be performed.

**CAUTION**

If oil pressure is below 10 psi, shut down engine immediately (maximum 30 seconds delay).

<b>NOTE</b>
-------------

Oil Pressure may advance above the green arc until Oil Temp. reaches normal operating temperatures.

Regulate warm up RPM to maintain pressure below 100 psi limit. At ambient temperatures below 32°F (0°C) **DO NOT** apply full power if oil pressure is above 70 psi.

**(c) After Engine has Started**

<b>CAUTION</b>
----------------

**IT IS DANGEROUS** to approach an aircraft with its engine operating. Only ground personnel properly trained on procedures for approaching operating aircraft should be allowed to disconnect EPU source. Practice the removal of the power cord before attempting with engine operating. Never approach the aircraft without a signal from the pilot. Ensure the aircraft is parked over an area of pavement where there is a sure footing. Protect Eyes and Ears when near the operating engine.

- |     |   |                                   |
|-----|---|-----------------------------------|
| 14. | <b>Select the EPU switch to OFF.</b>                | <b>EPU light ON</b>               |
| 15. | <b>Signal the ground crew to PULL the EPU cord.</b> | <b>EPU light OFF</b>              |
| 16. | <b>Master Switch (GEN)</b>                          | <b>OFF</b>                        |
| 17. | <b>Battery Voltage</b>                              | <b>check approx. 12 volts</b>     |
| 18. | <b>Master Switch (GEN)</b>                          | <b>ON, check approx. 14 volts</b> |
| 19. | <b>GEN warning light</b>                            | <b>check OFF</b>                  |

**5. PERFORMANCE**

There is no change in airplane performance associated with EPU operations.

**6. WEIGHT AND BALANCE / EQUIPMENT LIST**

Refer to Equipment List, Chapter 6.5,

Item Number 24-002 (Aircraft S/N C0001 through C0148 and C0150)

Item Number 24-005 (Aircraft S/N C0149 and C0151 onwards)





**CHAPTER 9**  
**SUPPLEMENT 2**  
**WINTERIZATION KIT**

<b>1</b>	<b>GENERAL</b>	<b>S2-2</b>
<b>2</b>	<b>OPERATING LIMITATIONS</b>	<b>S2-2</b>
<b>3</b>	<b>EMERGENCY PROCEDURES</b>	<b>S2-3</b>
<b>4</b>	<b>NORMAL PROCEDURES</b>	<b>S2-3</b>
<b>5</b>	<b>PERFORMANCE</b>	<b>S2-3</b>
<b>6</b>	<b>WEIGHT AND BALANCE</b>	<b>S2-3</b>
<b>7</b>	<b>DESCRIPTION OF THE AIRPLANE AND ITS SYSTEMS</b>	<b>S2-4</b>
<b>8</b>	<b>HANDLING, PREVENTIVE AND CORRECTIVE MAINTENANCE</b>	<b>S2-4</b>

## 1. GENERAL

The Winterization Kit consists of cowling inlet and outlet baffles. The inlet baffles are attached to the upper cowling with two winged ¼-turn fasteners. The outlet baffles are attached to the lower cowling with screws. At take-off outside air temperatures below 14°F/-10°C it is recommended to use both inlet and outlet baffles together. At temperatures between 32°F/0°C and 54.5°F/12.5°C it is not permissible to use both inlet and outlet baffles together. Either the inlet baffles only or the outlet baffles only may be used in this temperature range. At temperatures above 54°F (12.5°C) both inlet baffles and outlet baffles must be removed. These temperature ranges have been established by test to prevent the engine from overheating during a prolonged climb.

It is recommended to install the outlet baffles during periods when the take-off temperatures are consistently below 32°F/0°C. The inlet baffles can be installed or removed as required.

The installation is defined by Service Bulletin DAC1-71-03.

## 2. OPERATING LIMITATIONS

Maximum T/O outside air temperature with either inlet or outlet baffles installed is 54°F (12.5°C).

Maximum T/O outside air temperature with both inlet and outlet baffles installed is 32°F (0°C).

The following placard must be installed on the cowling, immediately below the oil filler door and on the removable baffles:

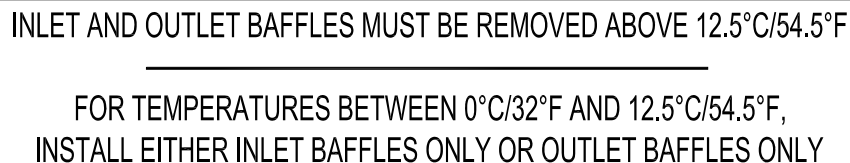

INLET AND OUTLET BAFFLES MUST BE REMOVED ABOVE 12.5°C/54.5°F

---

FOR TEMPERATURES BETWEEN 0°C/32°F AND 12.5°C/54.5°F,  
INSTALL EITHER INLET BAFFLES ONLY OR OUTLET BAFFLES ONLY

### 3. EMERGENCY PROCEDURES

There is no change to the airplane emergency procedures when the Winterization Kit is installed.

### 4. NORMAL PROCEDURES

Preflight Inspection:

[Insert after Item 7 (c) of the Walk-around inspection (ref. section 4.4.1 of the Airplane Flight Manual)]

Install or remove winter kit baffles according to the following chart:

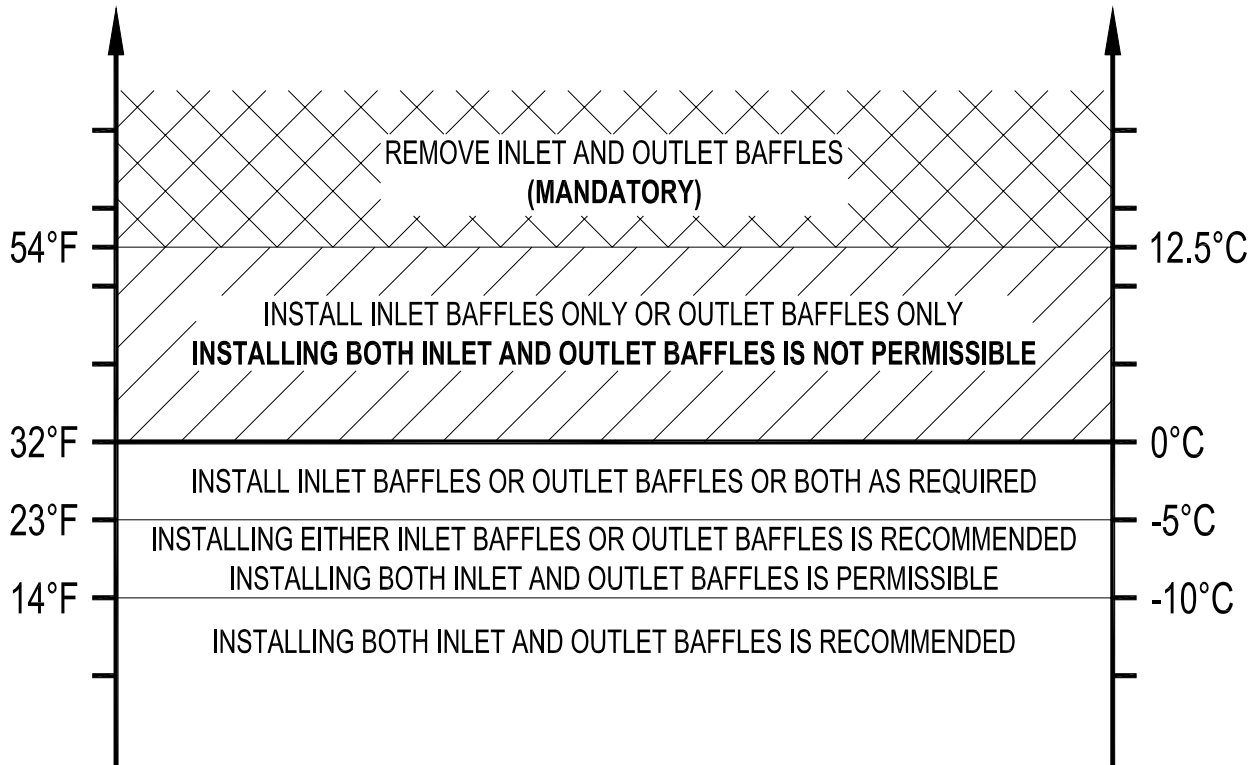

### 5. PERFORMANCE

There is no change in airplane performance when the Winterization Kit is installed.

### 6. WEIGHT AND BALANCE

The effect of the Winterization Kit on weight and balance is negligible.

## 7. DESCRIPTION OF THE AIRPLANE AND ITS SYSTEMS

The Winterization Kit consists of:

- left and right baffles installed in the forward cowling inlets,
- left and right baffles installed in the aft outlet opening of the lower cowling, and
- a placard located on the cowling below the oil door.

The baffles reduce the flow of cooling air through the cowling, thereby increasing the operating temperature of the engine. At moderate temperatures either the inlet or outlet baffles may be installed. At lower temperatures both inlet and outlet baffles should be installed.

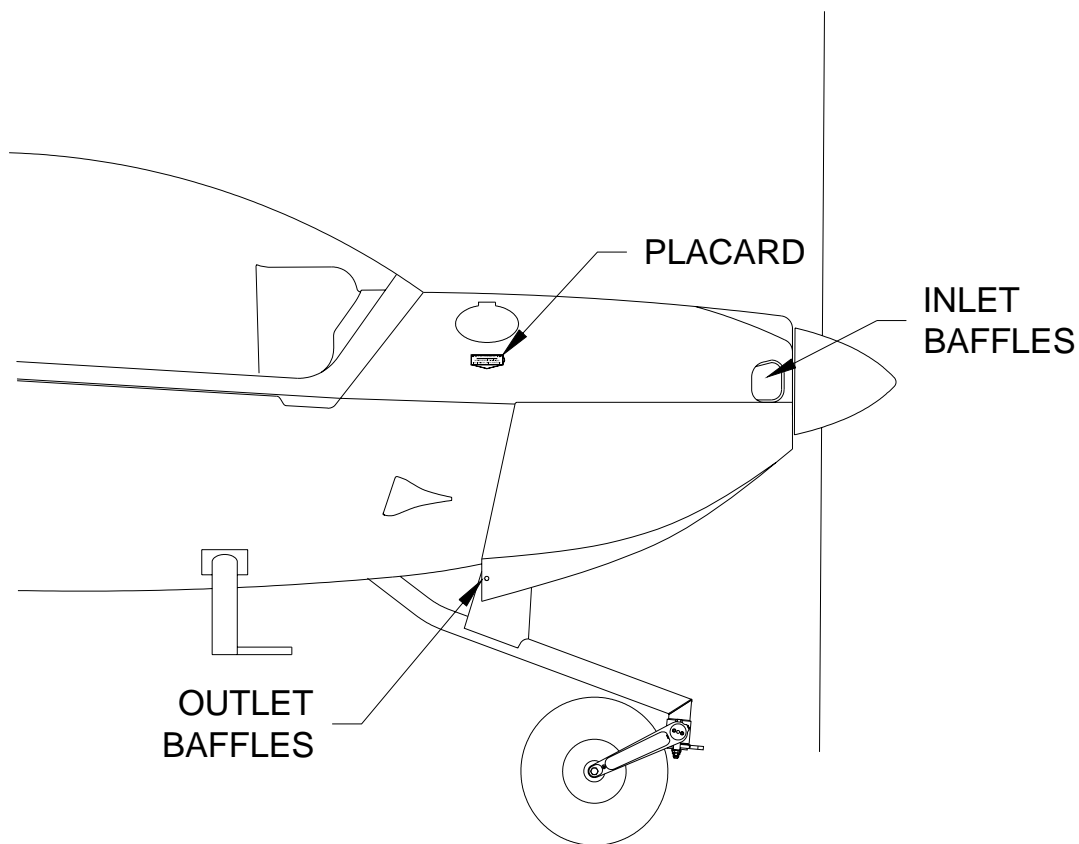

## 8. HANDLING, PREVENTATIVE AND CORRECTIVE MAINTENANCE

The inlet baffles are removed by unfastening two ¼-turn fasteners on each baffle. The outlet baffles are removed by unscrewing 5 attaching screws from the lower cowling. Store the screws and washers in the baffle rivnuts and store baffles in the baggage compartment.

CHAPTER 9  
SUPPLEMENT 3  
**RECOGNITION LIGHTS**

1	GENERAL	S3-2
2	OPERATING LIMITATIONS	S3-2
3	EMERGENCY PROCEDURES	S3-2
4	NORMAL PROCEDURES	S3-2
5	PERFORMANCE	S3-2
6	WEIGHT AND BALANCE	S3-2
7	DESCRIPTION OF THE AIRPLANE AND ITS SYSTEMS	S3-3
8	HANDLING, PREVENTIVE AND CORRECTIVE MAINTENANCE	S3-4

## 1. GENERAL

The installation is defined by Service Bulletin DAC1-33-01.

## 2. OPERATING LIMITATIONS

### 2.15. PLACARDS

#### 1. On the instrument panel above the individual circuit breakers



Figure 1.

## 3. EMERGENCY PROCEDURES

There are no changes to the airplane emergency procedures when the Recognition Lights are installed.

## 4. NORMAL PROCEDURES

Pulsing the landing/taxi lights enhances the aircraft flight path recognition quality and may be used any time the pilot desires. It is recommended that the landing lights be turned on steady rate when the aircraft is within 200' AGL at night.

### NOTE

Pulsing should not be used when operating near clouds or on the ground.

## 5. PERFORMANCE

There is no change in airplane performance with the Recognition Lights installed.

## 6. WEIGHT AND BALANCE

The Recognition Lights installation adds 2.5 lbs (1.13 kg) of weight at a 0 in (0 m) moment arm.

## 7. DESCRIPTION OF THE AIRPLANE AND ITS SYSTEMS

The Recognition Light System consists of 3, 35 watt lamps located in the left wing and the landing light. The lamps are aimed specifically to increase the aircraft's visibility on final approach and head on. One of the lamps is aimed to perform the function of the original taxi light. The 3 lamps and the original landing light are connected to a Pulselite power supply which allows one or more of the lights to be pulsed at approximately 46 times per minute. The instrument panel modifications include a Pulse Switch on the left side of the Lights switch panel and a Pulse System circuit breaker on the right side of the Lights panel (Figure 2).

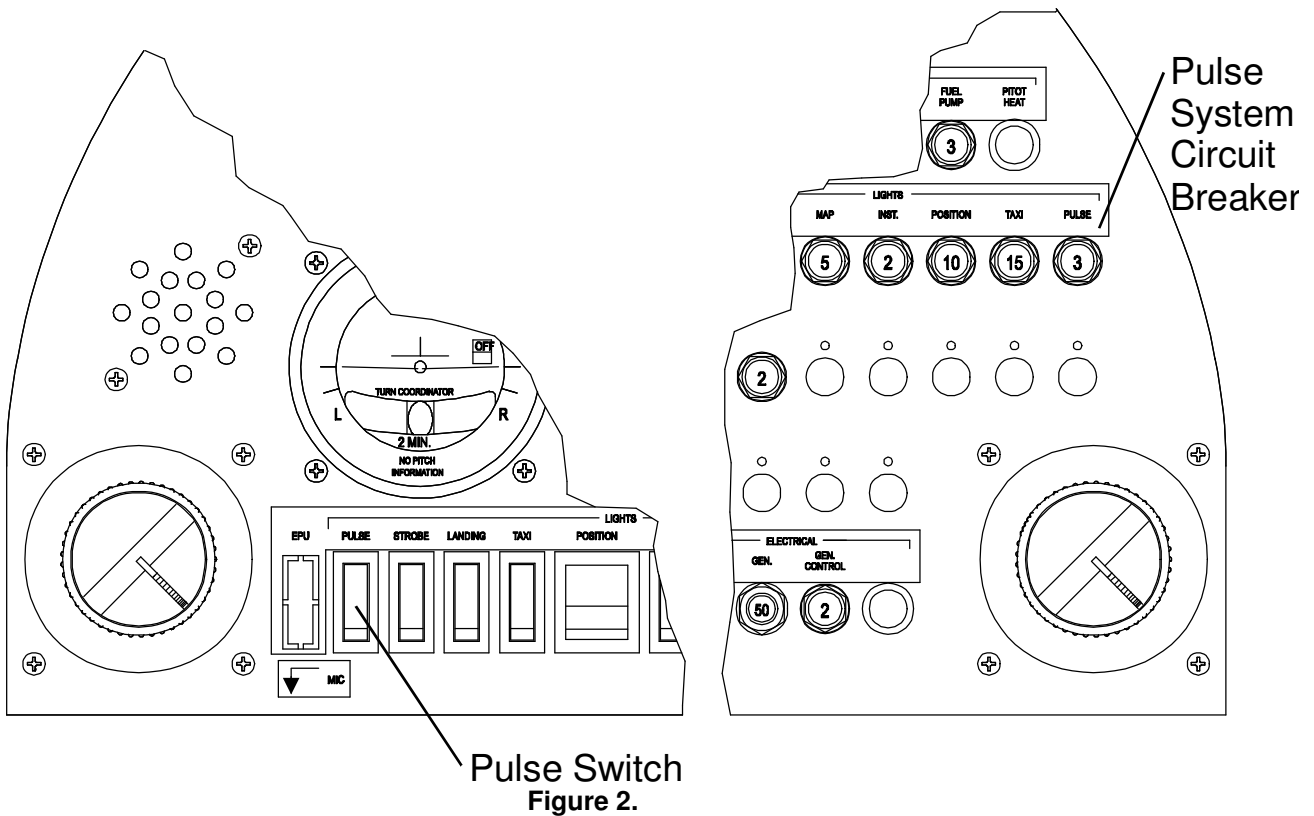

With the Taxi and Landing switches in the OFF position, selecting the Pulse switch to ON causes the three lamps and the landing light to pulse simultaneously. Selecting either the Taxi light or the Landing light to ON while the Pulse switch is in the ON position causes the corresponding lamp(s) to remain on steady. With the Pulse switch in the off position the Taxi light and Landing light function as normal light circuits.

## 8. HANDLING, PREVENTATIVE AND CORRECTIVE MAINTENANCE

Service or replacement of bulbs shall be performed according to chapter 33-00 of your Diamond Aircraft Maintenance Manual (Document number DA201-C1).



CHAPTER 9  
SUPPLEMENT 4  
**GROSS WEIGHT INCREASE (800 kg)**

1	GENERAL	S4-2
2	OPERATING LIMITATIONS	S4-2
3	EMERGENCY PROCEDURES	S4-5
4	NORMAL PROCEDURES	S4-6
5	PERFORMANCE	S4-6
6	WEIGHT AND BALANCE	S4-14
7	DESCRIPTION OF THE AIRPLANE AND ITS SYSTEMS	S4-16
8	HANDLING, PREVENTIVE AND CORRECTIVE MAINTENANCE	S4-16

**NOTE**

THIS SUPPLEMENT IS APPLICABLE ONLY TO THOSE AIRCRAFT WHICH ARE REGISTERED IN  
THE UNITED STATES OF AMERICA OR CANADA.

## 1. GENERAL

This supplement addresses the effects on the DA 20-C1 of an increase in the gross weight from 750 kg (1653 lbs) to 800 kg (1764 lbs) and is applicable only to aircraft with the Sensenich propeller. This increase of 50 kg (110 lbs) imposes no significant change to the control and stability of the aircraft. Only the portions of the flight manual affected by this weight increase are included in this supplement.

### 1.10. WEIGHT

Maximum Ramp Weight	: 803 kg (1770 lbs)
Maximum Take-off Weight	: 800 kg (1764 lbs)
Maximum Landing Weight	: 800 kg (1764 lbs)
Empty Weight	: See Chapter 6
Maximum Weight in Baggage Compartment	: 44 lbs (20 kg) only if restraining devices available

#### Wing Loading

At Maximum Take-off Weight	: 14.11 lbs/sq.ft. (68.96 kg/m <sup>2</sup> )
Performance Load at Max. Take-off Weight	: 14.11 lbs/hp (8.58 kg/kW)

## 2. OPERATING LIMITATIONS

### 2.7. WEIGHT

Maximum Ramp Weight	: 803 kg (1770 lbs)
Maximum permissible weight	: 800 kg (1764 lbs)
Maximum permissible weight in the baggage compartment (including baggage extension, if fitted)	: 44 lbs (20 kg) only permissible with baggage harness

#### WARNING

Exceeding weight limitations may lead to overloading of the airplane and cause loss of control of the airplane and/or structural damage.

#### NOTE

THIS SUPPLEMENT IS APPLICABLE ONLY TO THOSE AIRCRAFT WHICH ARE REGISTERED IN THE UNITED STATES OF AMERICA OR CANADA.

## 2.8 CENTER OF GRAVITY

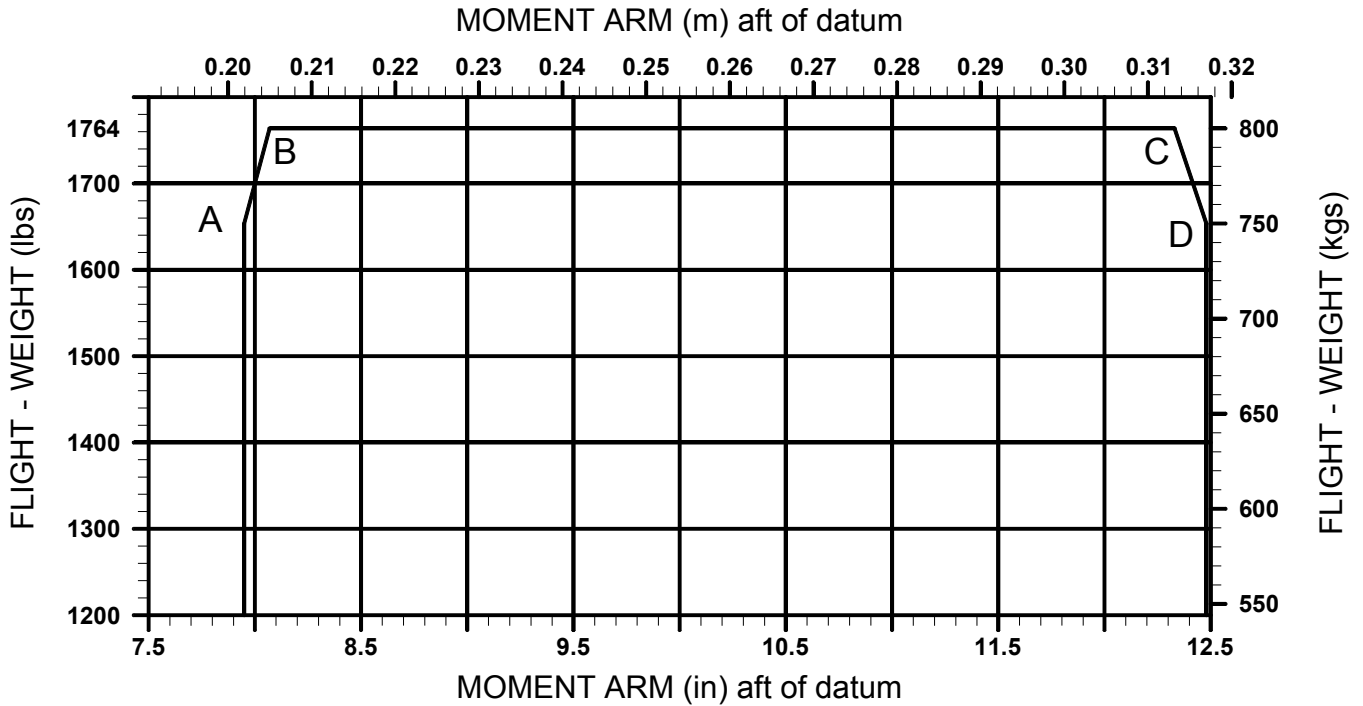

Points	Gross Weight		Arm (aft of datum)	
	(lbs)	(kgs)	(in)	(m)
A	1653	750	7.95	.202
B	1764	800	8.07	.205
C	1764	800	12.16	.309
D	1653	750	12.48	.317

### WARNING

Exceeding the center of gravity limitations reduces the manoeuvrability and stability of the airplane.

The procedure used to determine the center of gravity is described in Chapter 6.

### NOTE

THIS SUPPLEMENT IS APPLICABLE ONLY TO THOSE AIRCRAFT WHICH ARE REGISTERED IN THE UNITED STATES OF AMERICA OR CANADA.

## 2.9 APPROVED MANEUVERS

This airplane is certified in the UTILITY Category in accordance with Canadian Airworthiness Manual Chapter 523-VLA.

Permissible Utility Category Maneuvers:

- a) All normal flight maneuvers
- b) Lazy Eight's                      Entry speed: 116 KIAS  
Chandelles:                      Entry speed: 116 KIAS  
Steep turns in which the angle of bank does not exceed 60
- c) Spinning NOT approved for aircraft equipped with altitude compensating fuel system.
- d) Spinning (with Wing Flaps UP) approved for aircraft NOT equipped with altitude compensating fuel system.
- e) Stalls NOT approved for aircraft equipped with altitude compensating fuel system and not in compliance with MSB DAC1-73-05 latest approved revision.
- f) Stalls (except whip stalls) approved for aircraft NOT equipped with altitude compensating fuel system
- g) Stalls (except whip stalls) approved for aircraft equipped with altitude compensating fuel system in compliance with MSB DAC1-73-05 latest approved revision.
- h) Intentional Side Slips, except as required for landings, NOT approved for aircraft equipped with altitude compensating fuel system and not in compliance with MSB DAC1-73-05 latest approved revision.

<b>NOTE</b>
-------------

Aerobatics are prohibited.

<b>NOTE</b>		
THIS SUPPLEMENT IS APPLICABLE ONLY TO THOSE AIRCRAFT WHICH ARE REGISTERED IN THE UNITED STATES OF AMERICA OR CANADA.		
DA202-C1 Revision 23	December 11, 2007	Page S4 - 4

### 3. EMERGENCY PROCEDURES

#### 3.2. AIRSPEEDS DURING EMERGENCY PROCEDURES AT 800 kg.

	KIAS
Engine failure after take-off with flaps in T/O position	60
Maneuvering Speed	106
<b>Airspeed for best glide angle</b> <b>Maximum Gross Weight</b>	
Wing Flaps in CRUISE position                      800 kg (1764 lbs)	73
Precautionary Landing (with power and Wing Flaps in landing position)	55
Emergency landing with engine off (Wing Flaps in T/O position)	60
Emergency landing with engine off (Wing Flaps in LDG position)	55
Emergency landing with engine off (Wing Flaps CRUISE)	64

#### NOTE

THIS SUPPLEMENT IS APPLICABLE ONLY TO THOSE AIRCRAFT WHICH ARE REGISTERED IN THE UNITED STATES OF AMERICA OR CANADA.

## 4. NORMAL PROCEDURES

### 4.2 AIRSPEEDS FOR NORMAL FLIGHT OPERATION

LANDING	KIAS
Approach speed for normal landing. Wing Flaps LDG	55

## 5. PERFORMANCE

### 5.3. PERFORMANCE TABLE AND DIAGRAMS

#### 5.3.1 Figure 5.1: Airspeed System Calibration

Assumes zero indicator error

Flaps Cruise																	
KIAS	44	50	55	60	65	70	75	80	90	100	110	120	130	140	150	160	164
KCAS	54 <i>V<sub>S1</sub></i>	58	62	66	70	75	79	83	92	101	110	120	129	138	147	156	159 <i>V<sub>NE</sub></i>
Flaps T/O																	
KIAS	40	45	50	55	60	65	70	75	80	85	90	95	100	105	---	---	---
KCAS	50 <i>V<sub>S1</sub></i>	53	57	61	65	69	73	77	81	85	89	93	96	100 <i>V<sub>FE</sub></i>	---	---	---
Flaps LDG																	
KIAS	36	40	45	50	55	60	65	70	75	82	---	---	---	---	---	---	---
KCAS	45 <i>V<sub>S0</sub></i>	48	52	55	59	64	68	72	76	81 <i>V<sub>FE</sub></i>	---	---	---	---	---	---	---

*Example:* CRUISE Flap KIAS = 90 kts therefore KCAS = 92 kts from chart

### NOTE

THIS SUPPLEMENT IS APPLICABLE ONLY TO THOSE AIRCRAFT WHICH ARE REGISTERED IN THE UNITED STATES OF AMERICA OR CANADA.

### 5.3.3. Figure 5.3: Stall Speeds

Configuration:

Idle, most forward center of gravity, max. weight of 800 kg  
(this is the most adverse configuration)

Stall speeds in **kts**

Most Forward Center of Gravity								
Flap Setting	Angle of Bank							
	0°		30°		45°		60°	
	KIAS	KCAS	KIAS	KCAS	KIAS	KCAS	KIAS	KCAS
Cruise	44	54	49	58	57	64	72	76
Take-off	40	50	46	53	53	59	66	70
Landing	36	45	41	49	48	54	61	64

#### NOTE

THIS SUPPLEMENT IS APPLICABLE ONLY TO THOSE AIRCRAFT WHICH ARE REGISTERED IN THE UNITED STATES OF AMERICA OR CANADA.

Figure 5.5: Take-off Distance  
SENSENICH PROPELLER

W69EK7-63, W69EK7-63G and W69EK-63

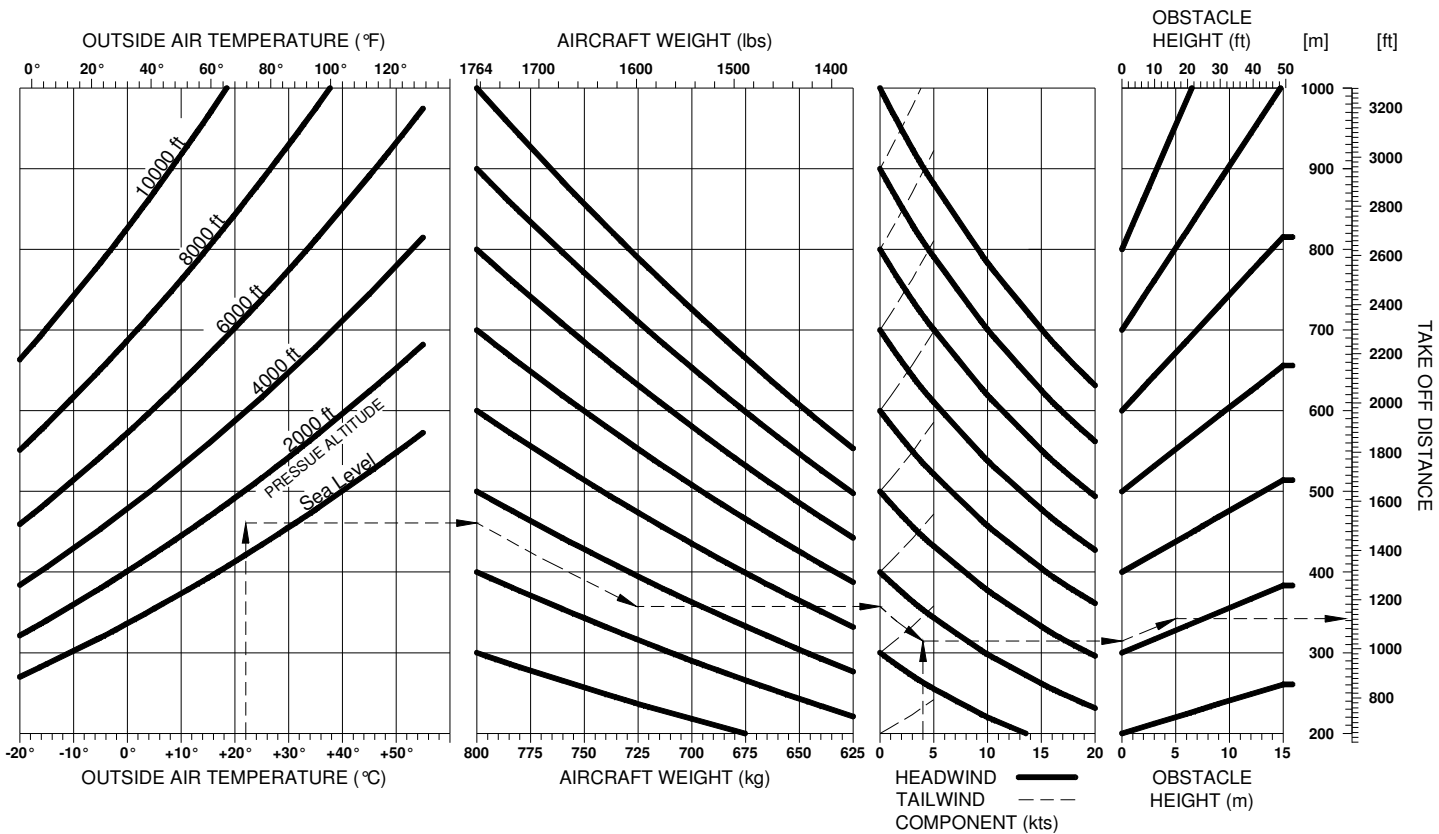

**RESULT:**  
 > Take-off distance to clear a 16 ft (5m) obstacle  
 1122 ft (341 m)

**EXAMPLE:**  
 > Pressure altitude: 1000 ft  
 > Outside air temperature: 72 °F (22 °C)  
 > Weight: 1600 lbs (725 kg)  
 > Wind: 4 kt headwind

**CONDITIONS:**  
 > Maximum take-off power  
 > Lift-off speed 52 KIAS and speed for climb over obstacle 58 KIAS  
 > Level runway, paved  
 > Wing flaps in T/O position

**NOTE**

Poor maintenance condition of the airplane, deviation from the given procedures as well as unfavorable conditions ( i.e. high temperature, rain, unfavorable wind conditions, including cross wind) can increase the take-off distance considerably.

**NOTE**

THIS SUPPLEMENT IS APPLICABLE ONLY TO THOSE AIRCRAFT WHICH ARE REGISTERED IN THE UNITED STATES OF AMERICA OR CANADA.



**Figure 5.6 : Climb Performance / Cruising Altitudes**

**SENENICH PROPELLER**

**W69EK7-63, W69EK7-63G and W69EK-63**

Max. Cruising Altitude (in standard conditions): 13120 ft (4000 m)

Best Rate-of-Climb Speed with Wing Flaps CRUISE 75 KIAS

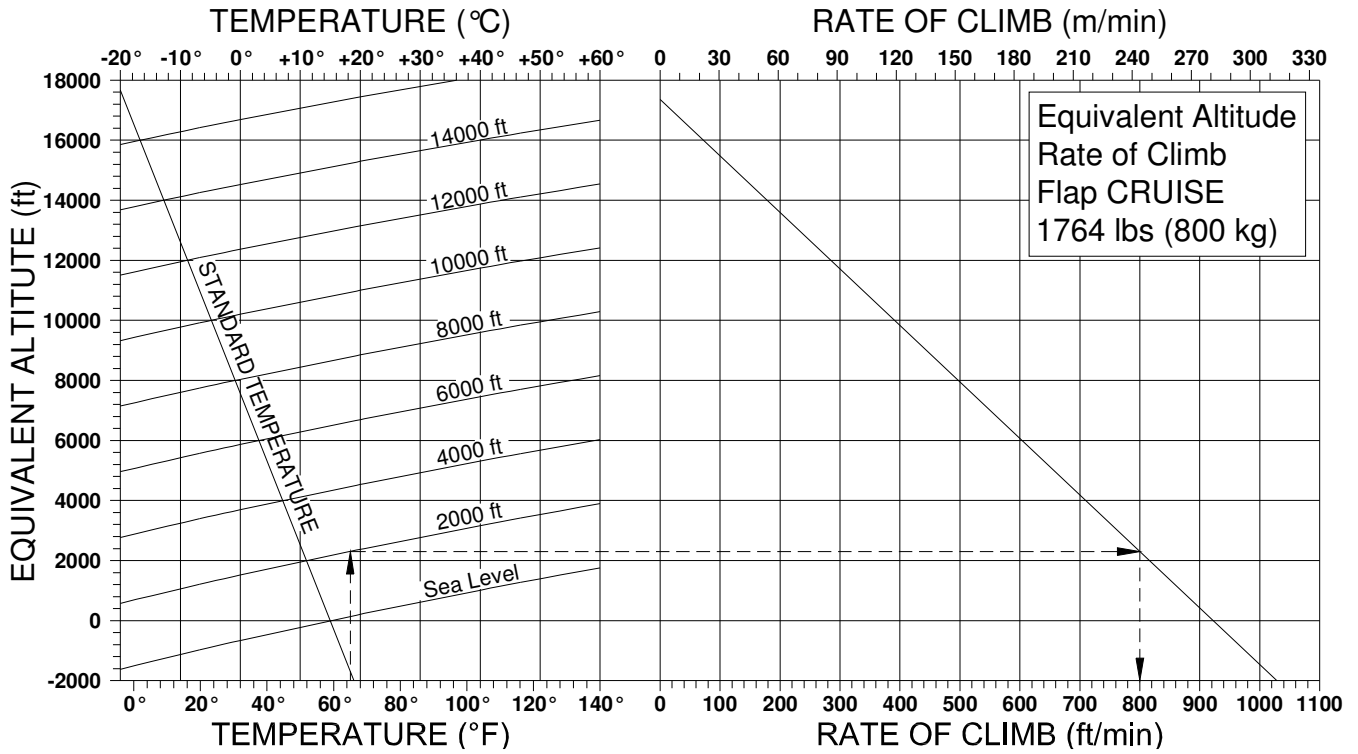

*Example:* Pressure Altitude: 2000 ft  
 OAT: 65° F  
 Weight : 1764 lbs  
*Result:* Climb performance: 800 ft/min

**NOTE**

THIS SUPPLEMENT IS APPLICABLE ONLY TO THOSE AIRCRAFT WHICH ARE REGISTERED IN THE UNITED STATES OF AMERICA OR CANADA.

**Figure 5.7 : Climb Performance / Take off**

**SENENICH PROPELLER**

**W69EK7-63, W69EK7-63G and W69EK-63**

Best Rate-of-Climb Speed with Wing Flaps T/O

68 KIAS

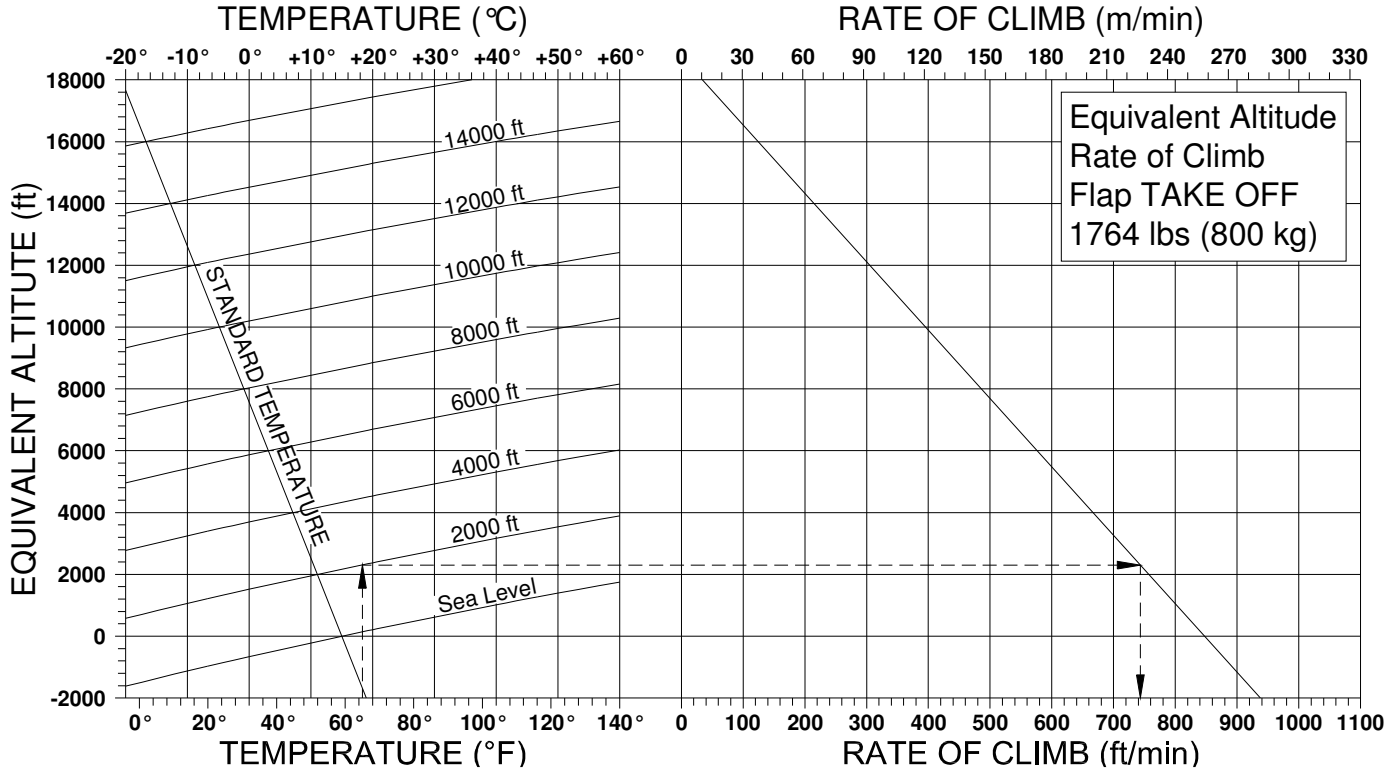

*Example:* Pressure Altitude: 2000 ft  
 OAT: 65° F  
 Weight : 1764 lbs  
*Result:* Climb performance: 744 ft/min

**NOTE**

THIS SUPPLEMENT IS APPLICABLE ONLY TO THOSE AIRCRAFT WHICH ARE REGISTERED IN THE UNITED STATES OF AMERICA OR CANADA.

**Figure 5.8: Cruising Speed (True Airspeed)**

**SENENICH PROPELLER**

**W69EK7-63, W69EK7-63G and W69EK-63**

Diagram for true airspeed (TAS) calculation at selected power level.

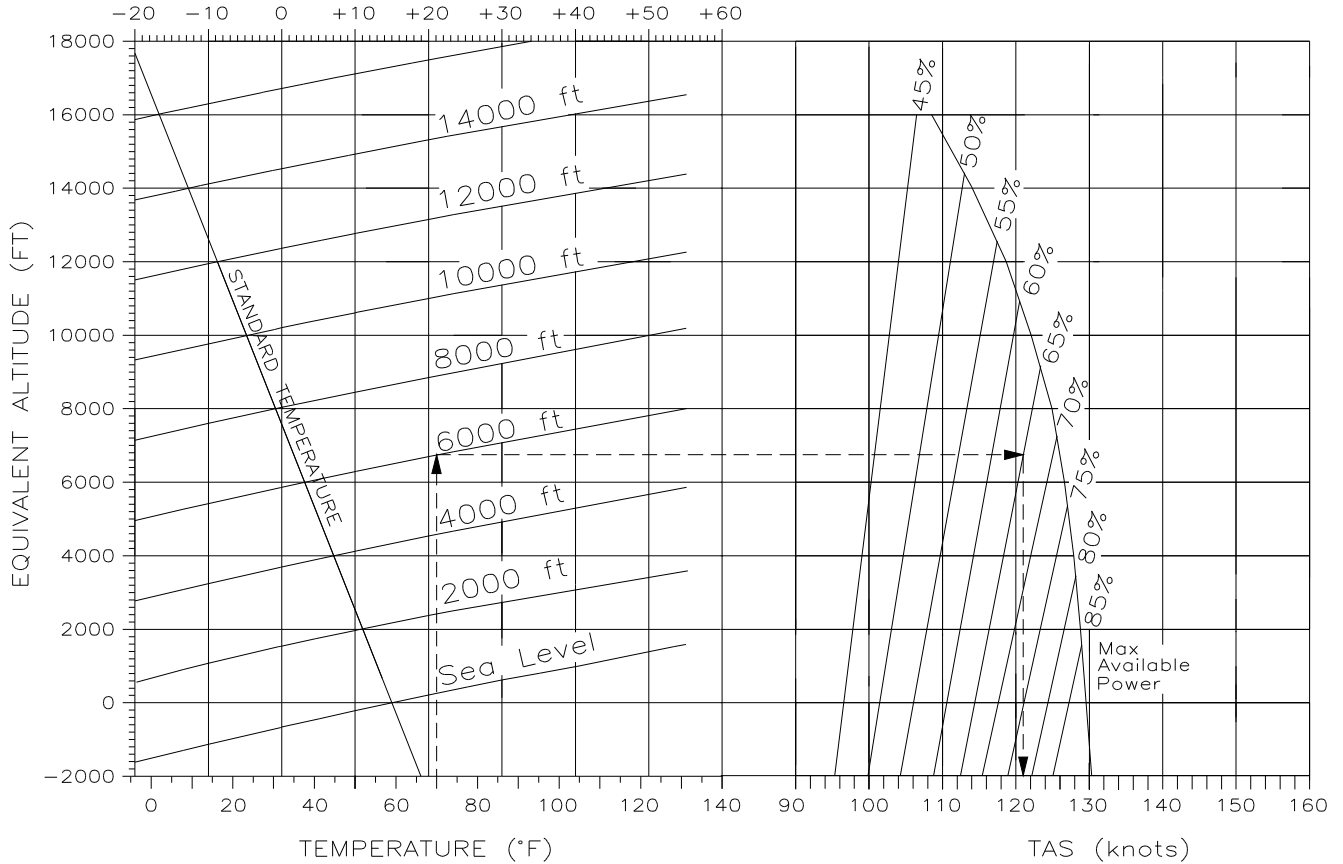

*Example:* Pressure altitude: 6000 ft.  
 Temperature: 70° F  
 Power setting: 65%

*Result:* True airspeed (TAS): 121kts

**NOTE**

THIS SUPPLEMENT IS APPLICABLE ONLY TO THOSE AIRCRAFT WHICH ARE REGISTERED IN THE UNITED STATES OF AMERICA OR CANADA.

**Figure 5.10: Climb Performance / Balked Landing**

**SENENICH PROPELLER**

**W69EK7-63, W69EK7-63G and W69EK-63**

Conditions: Speed = 52 KIAS  
 Wing Flaps in Landing Position (LDG)  
 max take-off power

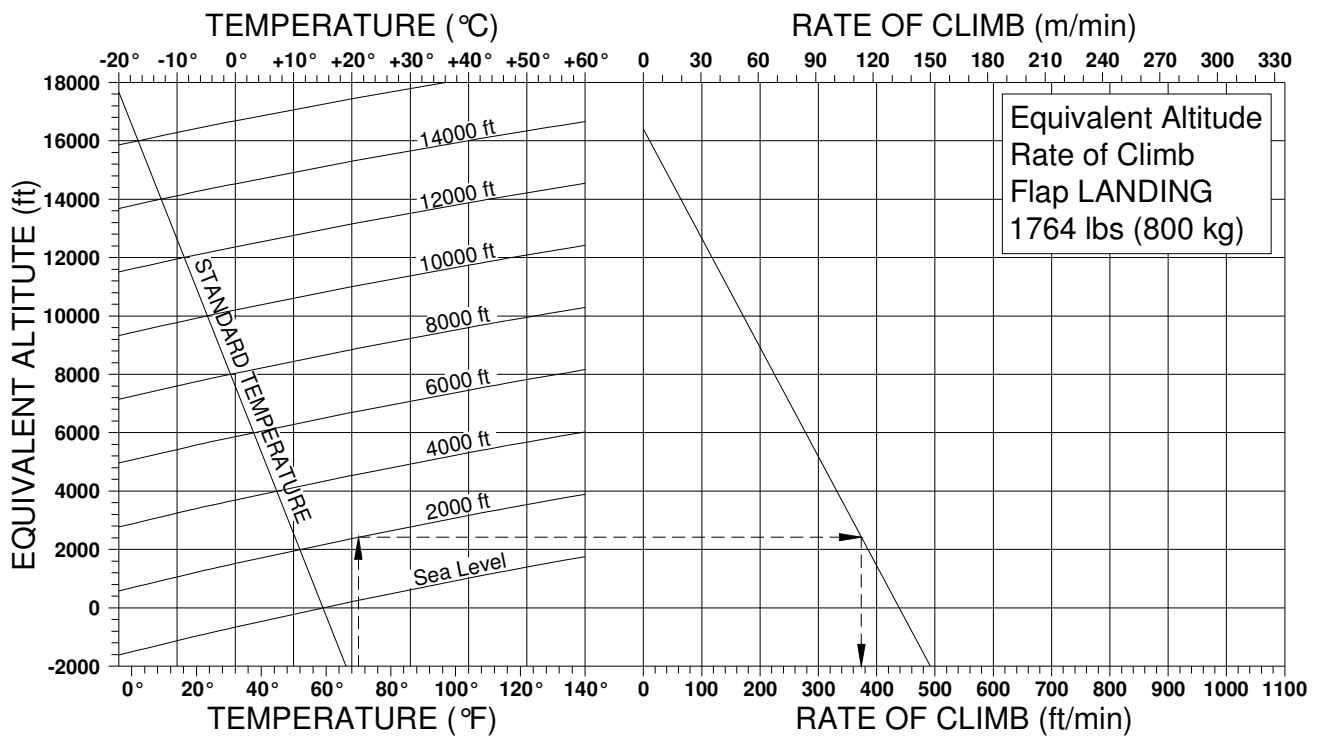

*Example:* Pressure altitude: 2000 ft  
 Outside temperature: 70°F

*Result:* Climb performance during balked landing: 374 ft/min

**NOTE**

THIS SUPPLEMENT IS APPLICABLE ONLY TO THOSE AIRCRAFT WHICH ARE REGISTERED IN THE UNITED STATES OF AMERICA OR CANADA.

### 5.3.11. Landing Distance

- Conditions:
- Throttle: Idle
  - Maximum T/O Weight
  - Approach Speed                      55 KIAS
  - Level Runway, paved
  - Wing Flaps in Landing position (LDG)
  - Standard Setting, MSL

Landing distance over a 50 ft (15 m) obstacle:    approx. 1360 ft (414m)

Landing roll distance:                                      approx. 661 ft (201m)

Figure 5.11: Landing and Rolling Distances for Heights Above MSL

Height above MSL	ft.	0	1000	2000	3000	4000	5000	6000	7000
	(m)	(0)	(305)	(610)	(914)	(1219)	(1524)	(1829)	(2134)
Landing Distance	ft.	1360	1387	1417	1447	1478	1511	1545	1580
	(m)	415	423	432	441	450	461	471	482
Landing Roll Distance	ft.	661	680	701	722	744	767	791	815
	(m)	201	207	214	220	227	234	241	248

**NOTE**

Poor maintenance condition of the airplane, deviation from the given procedures as well as unfavorable outside conditions (i. e. high temperature, rain, unfavorable wind conditions, slippery runway) could increase the landing distance considerably.

**NOTE**

Aircraft with ground idle speed set to 1000 RPM, landing distance increased approx. 5% and ground roll increased approx. 7%

## 5.4 Noise Data

Noise Measurement Method	Noise Value	Maximum Allowable
FAR36 Appendix G	71.7 dBA	75.7 dBA
ICAO Annex 16, Appendix 6	74.4 dBA	80.1 dBA

<b>NOTE</b>		
THIS SUPPLEMENT IS APPLICABLE ONLY TO THOSE AIRCRAFT WHICH ARE REGISTERED IN THE UNITED STATES OF AMERICA OR CANADA.		
DA202-C1 Revision 23	December 11, 2007	Page S4 - 13

## 6. WEIGHT AND BALANCE

Model: DA20-C1 Serial Number: \_\_\_\_\_ Registration \_\_\_\_\_

Data with reference to the Type Certificate Data Sheet and the Flight Manual.

Reference Datum: Leading edge of wing at root rib.

Horizontal reference line: Wedge 1000:55.84, 2000mm (78.7 in) aft of the step in the fuselage at the canopy edge.

Equipment list - dated: \_\_\_\_\_ Cause for Weighing: \_\_\_\_\_

### Weight and Balance Calculations

Weight Condition:

Include brake fluid, engine oil and Unusable fuel (Type 2 system, 2 liters unusable, 3.18 lbs/1.44 Kg)

Finding Empty Weight:

Finding Arm: (Measured)

Support	Gross ([kg]) (lbs)	Tare ([kg]) (lbs)	Net Weight ([kg]) (lbs)	Lever Arm ([m]) (in)
Front G <sub>1</sub>				X <sub>1</sub> =
Rear G <sub>2LH</sub>				X <sub>2LH</sub> =
Rear G <sub>2RH</sub>				X <sub>2RH</sub> =
EMPTY WEIGHT (G)				

Finding Empty - Weight Center of Gravity (X<sub>CG</sub>):

Empty Weight CG Formula:

$$X_{CG} = \frac{G_{2LH} (X_1 + X_{2LH}) + G_{2RH} (X_1 + X_{2RH})}{G_1 + G_{2LH} + G_{2RH}} - X_1 = \underline{\hspace{2cm}}$$

Finding Empty - Weight Moment

Empty-weight Moment (M) = Empty Weight (G) x Empty-weight CG (X<sub>CG</sub>) =

(Positive results indicate, that CG is located aft of RD) \_\_\_\_\_

Finding Maximum Permitted Useful Load:

Maximum Weight [kg] (lbs)	800 kg/1764 lbs
Empty Weight [kg] (lbs)	
Maximum useful Load [kg] (lbs)	

Empty Weight (G): ([kg]) (lbs)		Empty-weight Moment (M): ([kg·m]) (in·lbs)	
Place / Date	Authorizing Stamp	Authorizing Signature	

Figure 6.3. Weighing Report

### NOTE

THIS SUPPLEMENT IS APPLICABLE ONLY TO THOSE AIRCRAFT WHICH ARE REGISTERED IN THE UNITED STATES OF AMERICA OR CANADA.

**Figure 6.6:** Calculation of Loading Condition

Calculation of the Load Limits	DA 20 (Example)		Your DA 20	
	Weight [lbs]	Moment [in.lbs]	Weight [lbs]	Moment [in.lbs]
	(Weight [kg])	([kgm])	(Weight [kg])	([kgm])
1. Empty Weight (use the data for your airplane recorded in the equipment list, including unusable fuel and lubricant).	1153 (523)	12562 (144.740)		
2. Pilot and Passenger: Lever Arm: 0.143 m (5.63 in)	359 (163)	2021 (23.286)		
3. Baggage: Max. Wt. 44lbs (20kg) Lever Arm: 0.824 m (32.44 in)	-- (--)	-- (--)		
4. Baggage Compartment Extension: Max. Wt. 44lbs (20kg) Lever Arm: 1.575 m (62.0 in)	-- (--)	-- (--)		
5. *Combined Baggage Max. Wt. 44lbs (20kg) Lever Arm: 1.20 m (47.22 in)	-- (--)	-- (--)		
6. Total Weight and Total Moment with empty fuel tank (sum of 1. - 3.)	<b>1512</b> <b>(686)</b>	<b>14583</b> <b>(168.026)</b>		
7. Usable Fuel Load (6.01 lbs. per US gal./0.72 kg per liter) Lever Arm (32.44 in) (0.824 m)	93 (42)	3017 (34.762)		
8. Total Weight and Total Moment, taking fuel into account (sum of 6. and 7.)	<b>1605</b> <b>(728)</b>	<b>17600</b> <b>(202.788)</b>		
9. Find the values for the total weight (1512 lbs. and 1605 lbs.) and the total moment (14583 in lbs. and 17600 in.lbs.) in the center of gravity diagram. Since they are within the limitation range, the loading is permissible.				

\* Combined Baggage: For convenience of calculation use this line if baggage is to be located in both the baggage compartment and the baggage extension. The combined total of the baggage must not exceed 44 lbs (20 kg).

**NOTE**

THIS SUPPLEMENT IS APPLICABLE ONLY TO THOSE AIRCRAFT WHICH ARE REGISTERED IN THE UNITED STATES OF AMERICA OR CANADA.

**Figure 6.7: Permissible Center of Gravity Range and permissible Flight-Weight-Moment**

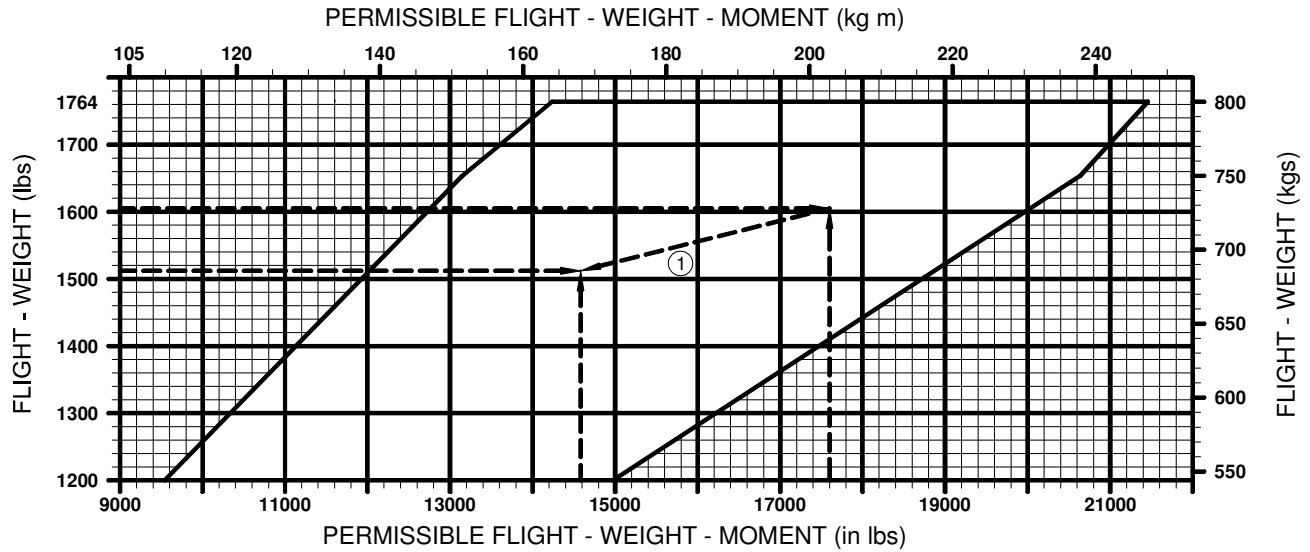

1. See example calculation of loading condition Figure 6.6. Change in center of gravity is due to fuel consumption

## 7. DESCRIPTION OF THE AIRPLANE AND ITS SYSTEMS

The gross weight increase to 800 kg. does not affect the description of the airplane and its systems.

## 8. HANDLING, PREVENTATIVE AND CORRECTIVE MAINTENANCE

The gross weight increase to 800 kg. does not affect the Handling, Preventative and Corrective Maintenance.

**NOTE**

THIS SUPPLEMENT IS APPLICABLE ONLY TO THOSE AIRCRAFT WHICH ARE REGISTERED IN THE UNITED STATES OF AMERICA OR CANADA.



CHAPTER 9  
SUPPLEMENT 5  
**S-Tec Autopilot**

1. GENERAL	S5- 2
2. OPERATING LIMITATIONS	S5- 2
3. EMERGENCY PROCEDURES	S5- 3
4. NORMAL PROCEDURES	S5- 4
5. PERFORMANCE	S5- 7
6. WEIGHT AND BALANCE	S5- 7
7. DESCRIPTION OF THE AIRPLANE AND ITS SYSTEMS	S5- 7
8. HANDLING, PREVENTATIVE AND CORRECTIVE MAINTENANCE	S5- 10

## 1. GENERAL

This supplement addresses the optional installation of an S-TEC System 30 autopilot (Mod No. 30). Only the portions of the flight manual affected by this installation are included in this supplement.

## 2. OPERATING LIMITATIONS

### NOTE

Refer to all of the Operating Limitations with the following inserted into the appropriate place.

1. Autopilot operation is prohibited for airspeeds greater than 148 KIAS.
2. Autopilot operation is prohibited during Takeoff and Landing
3. Maximum flap extension is T/O (15°) with the Autopilot operating.

### 2.4 Placards

ALT  
ENG/DISENG

AP DISC

**1. Forward of the switch on the outboard side of the control stick**

**2. Forward of the switch on the inboard side of the control stick**

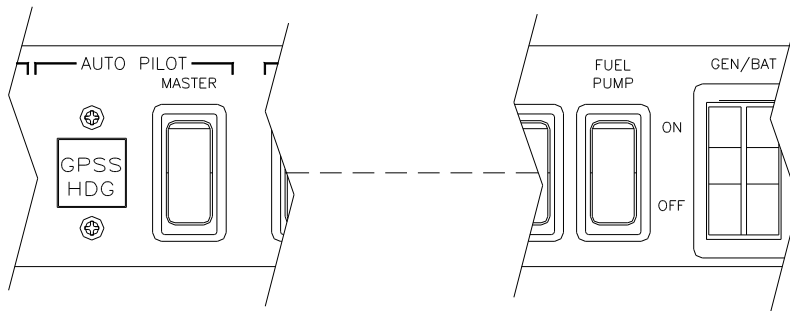

**3. On the switch panel on the lower left side of the instrument panel. The placard is customized to the installation and may not be exactly as shown**

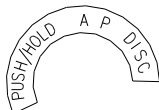

- AUTOPILOT MAX. OPERATING SPEED 148 KIAS
  - A/P OPS PROHIBITED FOR T/O & LDG.
  - MAX FLAP T/O (15°) WITH A/P ON.

**4. Around the 'Mode Select / Disconnect Switch' switch of the autopilot**

**5. On the instrument panel near the autopilot**

### 3. EMERGENCY PROCEDURES

#### 3.1 Autopilot Malfunction

<b>CAUTION</b>
----------------

In the event of an autopilot malfunction, or any time the autopilot is not performing as expected or commanded, do not attempt to identify the system problem.

Immediately regain control of the aircraft by overpowering the autopilot as necessary and then disconnect the autopilot.

Do not reengage the autopilot until the problem has been identified and corrected.

#### 1. Autopilot may be disconnected by:

- a. Depressing the "AP Disconnect" Switch on the right side of the pilot's control grip.
- b. Pressing and holding the mode selector knob for approximately 2 seconds.
- c. Moving the autopilot master switch to "OFF" position.
- d. Pulling the autopilot circuit breaker.

#### 2. Altitude loss during a malfunction and recovery.

- a. The following altitude losses and bank angles were recorded after a malfunction with a 3 second recovery delay:

<u>Configuration</u>	<u>Bank Angle/Altitude Loss</u>
Climb / Descent / Cruise	55° / -20'

- b. The following altitude losses and bank angles were recorded after a malfunction with a 1 second recovery delay:

<u>Configuration</u>	<u>Bank Angle/Altitude Loss</u>
Maneuvering	20° / -20'
Approach (coupled or uncoupled)	15° / -20'

## 4. NORMAL OPERATING PROCEDURES

<b>NOTE</b>
-------------

Refer to all of the Normal Operating Procedures with the following inserted into the appropriate places.

### 4.4. NORMAL OPERATION CHECKLIST

#### 4.4.1. Preflight Inspection

##### II. Walk Around Check and Visual Inspection

##### 2. Left Wing

- (j) Autopilot Static Port check clear

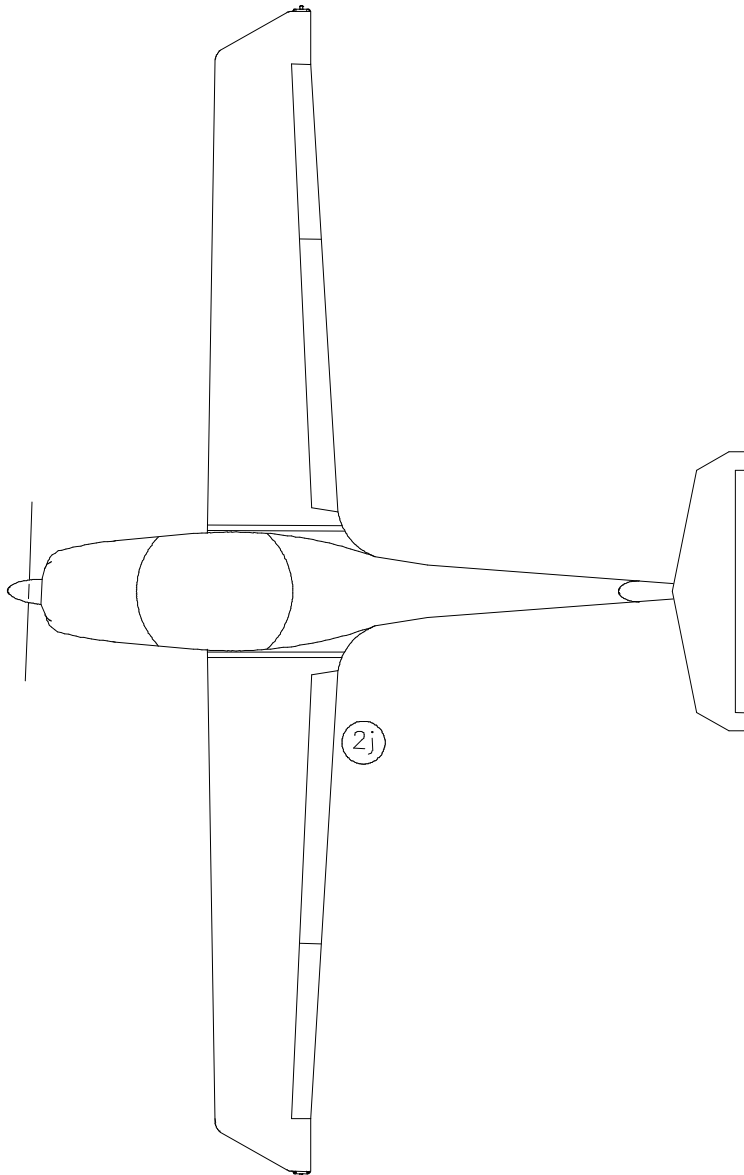

**4.4.4. Before Taxiing**

2.a	AP Master Switch	ON (if desired)
2.b	Autopilot Mandatory Pre-flight Test	COMPLETE

**Autopilot Mandatory Pre-flight Test**

- A. Observe all lights and annunciators illuminate.
- B. Observe the following light sequence of the trim indicators:  
(Sequence requires 9 seconds).
  - 1. Initially both trim UP and DN lights are illuminated.
  - 2. UP light extinguishes and remains off.
  - 3. DN light then extinguishes and remains off.
  - 4. All lights extinguish except for "RDY" light.

The autopilot can be engaged and disengaged repeatedly using the mode selector knob. The autopilot can be disengaged using the A/P disconnect switch. Once the A/P master is switched off, the test must be reconducted to get a ready indication. If the ready light does not illuminate after the test, a failure to pass the test is indicated and the system will require service.

**Altitude mode cannot be engaged unless power is on for more than 15 seconds.**

**System Functional Test**

1. Push Mode Switch – STB Annunciator illuminates. Rotate 'Mode Select' knob left and right. Observe control stick moves in corresponding direction. Centre turn knob.
2. Set D.G. and place heading bug under lubber line (if installed). Push 'Mode Select' knob to engage HDG mode. Observe HDG annunciator. Move HDG bug left and right. Observe proper control stick motion.
3. Overpower test – Grasp control stick and overpower roll servo left and right. Overpower action should be smooth with no noise or jerky feel. If unusual sound or excessive play is detected, have the servo installation inspected prior to flight.
4. Radio Check –
  - A. Turn on NAV Radio, with valid NAV signal, engage LO TRK mode and move VOR OBS so that VOR needle moves left and right – control stick should follow the direction of needle movement.
  - B. Select Hi TRK mode – the control stick should again follow radio needle movement and with more authority than produced by Lo TRK mode.



**4.4.11. Landing Approach**

- 1. Autopilot Disengaged (AP DISC)

**5. PERFORMANCE**

There is no change in airplane performance with the autopilot system installed.

**6. WEIGHT AND BALANCE**

The installation adds 11.1 lbs (5.0 kg) of weight at a -24.6 in (-.62 m) arm.

**7. DESCRIPTION OF THE AIRPLANE AND ITS SYSTEMS**

**7.15. System Description**

The System 30 is a pure rate autopilot which uses an inclined rate gyro in the Turn Coordinator instrument as the primary roll and turn rate sensor and an accelerometer and an absolute pressure transducer as pitch rate sensors. The turn coordinator includes an autopilot pick-off, a gyro RPM detector and an instrument power monitor. Low electrical power will cause the instrument "flag" to appear while low RPM will cause the autopilot to disconnect. The autopilot includes an automatic pre-flight test feature that allows a visual check of all the annunciator lamps and checks critical elements of the accelerometer system. The test feature will not enable autopilot function unless the automatic test sequence is satisfactorily completed.

When the pre-flight test is satisfactorily completed and when the rate gyro RPM is correct, the green "RDY" light will illuminate indicating the autopilot is ready for the functional check and operation. The autopilot cannot be engaged unless the "RDY" light is illuminated.

A Directional Gyro (DG) or compass system supplies heading information to the autopilot by a heading bug in the instrument.

Pitch axis control is provided for the altitude hold function by use of the accelerometer and the pressure transducer. When the altitude hold mode is engaged an elevator trim sensor in the pitch servo will detect the elevator trim condition. When elevator trim is necessary to re-establish a trimmed condition, trim indicator lights on the Turn Coordinator will illuminate to indicate the direction to trim to restore a trimmed condition. In addition to the indicator lights an audible tone will sound.

If the pilot ignores a trim light for more than five seconds, the light will begin to flash to get the pilot's attention.

The indicator and annunciator lamp brilliance is controlled through the aircraft instrument light rheostat, except for the "trim" indicators, which always illuminate at full intensity.

The following list describes the various features illustrated in Figure 1.

- 1. Turn Coordinator,— Provides basic flight information, autopilot mode switching and annunciation.

Doc # DA202-C1 Revision 8	December 7, 1999	Page S5 - 7 DOT Approved
------------------------------	------------------	-----------------------------

2. Mode Annunciation window – displays mode in use.
3. Green ready (RDY) Light – Illuminates when autopilot is ready for engagement. When autopilot is disconnected, "RDY" will flash for five seconds accompanied by a beeping audio tone.
4. Mode Select/Disconnect Switch – Each momentary push of this knob will select an autopilot mode, left to right, beginning with ST (Stabilizer) mode and ending with (Hi) TRK mode. Holding the knob in for more than 2 seconds will disconnect the autopilot. Turning the knob left or right in the stabilizer mode will provide left/right commands to the autopilot proportional to knob displacement up to a standard rate turn.
5. Altitude Hold Engage/Disengage Switch – This control stick mounted switch will engage or disengage the Altitude Hold Mode as desired. The blue (ALT) light on the annunciator panel will illuminate when ALT. mode is engaged.
6. Heading Mode – If the system is equipped with a D.G., this mode will permit preselected left/right turns using the D.G. heading bug.
7. TRK (Track) – using the (Lo) mode of the tracking feature will provide low system gain for comfortable cross country tracking of VOR or GPS signals. Using the (Hi) mode of the tracking feature will provide a higher level of system gain for more active tracking of VOR, GPS or Localizer front course signals.
8. Trim UP Light – Illuminates to indicate the need for nose UP trim.
9. Trim DOWN Light – Illuminates to indicate the need for nose DOWN trim. When both lights are out, the aircraft is in trim longitudinally.
10. Blue (ALT) light illuminates when altitude mode is engaged.
11. Flag Window – Red flag visible indicates lack of electrical power to primary turn coordinator unit.
12. Autopilot Master ON-OFF Switch – Refer to pre-flight procedures for operating details.
13. Remote AP disconnect switch.
14. GPSS Heading Switch / Annunciator. Works in conjunction with 'HDG' mode. When the GPSS is activated the GPSS converter changes ARINC 429 steering data received from the GPS to heading signals.



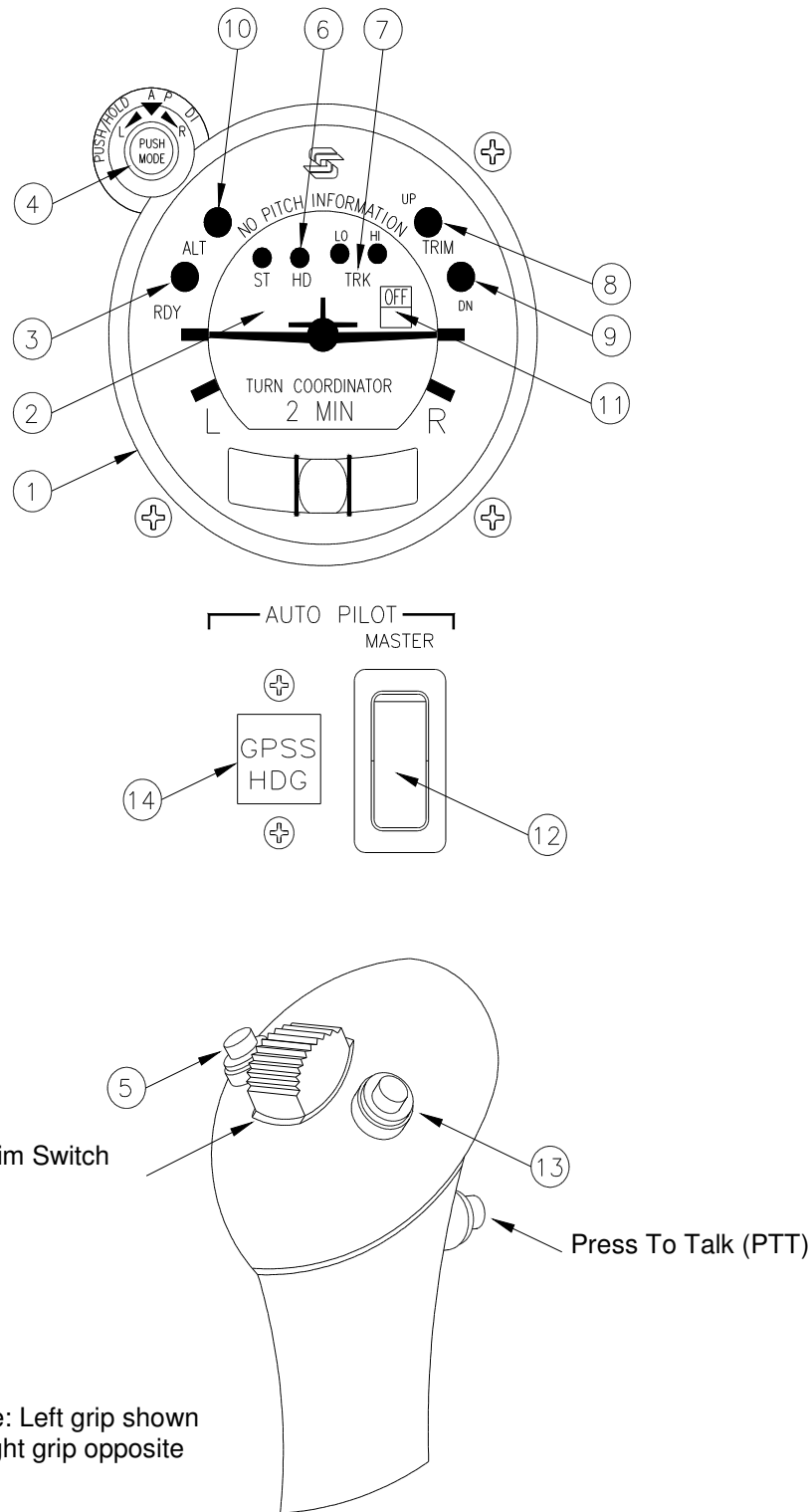

Figure 1

**8. HANDLING, PREVENTATIVE AND CORRECTIVE MAINTENANCE**

Service and maintenance of the System 30 Autopilot system shall be performed according to the Diamond Aircraft Maintenance Manual (Document number DA201-C1).

Doc # DA202-C1 Revision 8	December 7, 1999	Page S5 - 10 DOT Approved
------------------------------	------------------	------------------------------

CHAPTER 9  
SUPPLEMENT 6  
**VM1000 Monitoring System**

1. GENERAL	S6 -2
2. OPERATING LIMITATIONS	S6 -2
3. EMERGENCY PROCEDURES	S6 -2
4. NORMAL PROCEDURES	S6 -4
5. PERFORMANCE	S6 -4
6. WEIGHT AND BALANCE	S6 -4
7. DESCRIPTION OF THE AIRPLANE AND ITS SYSTEMS	S6 -4
8. HANDLING, PREVENTATIVE AND CORRECTIVE MAINTENANCE	S6 - 7

## 1. GENERAL

This supplement addresses the optional installation of the Vision Microsystems VM1000 engine instrument package (Mod 31). Only portions of the flight manual affected by the installation are included in this supplement.

## 2. OPERATING LIMITATIONS

### 2.1. Placards

EGT/CHT GRAPH	EGT/CHT DIGITAL	AUTOTRACK ON/OFF	FUEL/COMP MODE	FLIGHT DATA
------------------	--------------------	---------------------	-------------------	----------------

1. Under the buttons of the VM 1000 main display

## 3. EMERGENCY PROCEDURES

### 3.3 Emergency Procedures Checklist

#### 3.3.1

- a) VM 1000 and EC 100 Display Malfunction
  - 1) Instrument Circuit Breaker                      PRESS IN or PULL and RESET

### NOTE

If indication cannot be restored take care not to shock cool the engine during a descent. Electrical system voltage can be monitored on M803 Clock / OAT / Volt Meter if installed.

- 4)            Airspeed.    Do not exceed 115 KIAS
- 5)            If indication cannot be restored                      Land at suitable airport

#### 3.3.2

##### a) Generator Failure

GEN. Annunciator Illuminated

- |  |  |
|--|--|
| <ol style="list-style-type: none"> <li>1. GEN/BAT Master Switch</li> <li>2. Generator Circuit Breaker</li> <li>3. Generator CONTROL Circuit Breaker</li> <li>4. If Generator can not be brought on-line</li> </ol> | <p>Cycle Generator Master Switch OFF - ON<br/>If tripped, reset<br/>If tripped, reset<br/>Switch OFF all non-flight essential electrical consumers. Monitor Voltmeter. Land at nearest suitable airport.</p> |
|--|--|

<b>NOTE</b>
-------------

There is 30 minutes of battery power at a discharge load of 20 amperes when the battery is fully charged and properly maintained. The amp meter monitors generator load which will indicate low amps when the generator is off or has malfunctioned.

**c) Low Voltage Indication (needle in yellow Arc)**

**I. LOW VOLTAGE INDICATION (NEEDLE IN YELLOW ARC) WHILE AIRPLANE ON GROUND**

- |    |   |   |
|----|---|---|
| 1. | Engine RPM  | Increase RPM until needle is in the Green Arc. This should occur before exceeding 1100 RPM. |
| 2. | Non-flight essential electrical consumers   | Switch OFF consumers until needle is in the Green Arc.                                      |
| 3. | If needle remains in the yellow arc and the ammeter low generator amps (display flashing) | Discontinue any planned flight activity   |

**II. LOW VOLTAGE INDICATION (NEEDLE IN YELLOW ARC) DURING FLIGHT**

- |    |   |   |
|----|---|---|
| 1. | All non-flight essential electrical consumers   | Switch OFF                                      |
| 2. | If needle remains in the yellow arc and the ammeter low generator amps (display flashing) | Generator Failure: Refer to paragraph 3.3.2 (a) |

**III. LOW VOLTAGE INDICATION (NEEDLE IN YELLOW ARC) DURING LANDING:**

After landing

proceed in accordance with paragraph 3.3.2 (a).

<b>WARNING</b>
----------------

If at any time the Voltmeter needle indicates in the red arc, you should land at the nearest suitable airfield and service the aircraft accordingly before continuing the flight.

## 4. NORMAL PROCEDURES

### NOTE

There is no change in the normal procedures with the VM 1000 and EC 100 monitoring system installed. Although there are no necessary changes to the normal procedures, Section 7 contains a description of some of the operating modes and functions that may be used, if desired by the pilot, as enhancements to the normal procedures.

## 5. PERFORMANCE

There is no change in airplane performance with the VM1000 installed.

## 6. WEIGHT AND BALANCE

The installation adds 3.13 lbs ( 1.37 kg) of weight at a –34.3 in (-0.88 m) moment arm with the EC 100 option installed and the standard aircraft instruments removed

The installation adds 2.44 lbs ( 1.06 kg) of weight at a –39.4 in (-1.01 m) moment arm without the EC 100 option installed and the standard aircraft instruments removed.

## 7. DESCRIPTION OF THE AIRPLANE AND ITS SYSTEMS

### 7.1. VM 1000 System General

The following provides a general description for use of the VM 1000 as it pertains to the operation of the DA20-C1. Features such as 'Autotrack' 'Lean Mode' and 'EC 100" are described in detail in the VISON MICRO SYSTEM owners manual P/N 5010002. Copies of the manual can be obtained through.

Vision Micro Systems Inc.  
4071 Hannegan Suite T  
Bellingham, Washington 98226  
Phone (360) 714-8203 Fax (360) 714-8253

### 7.2. Tachometer

The tachometer system provides an analog display and a four place digital display. Color range marks provide a quick reference to monitor normal, and red line engine RPM.

RPM: The digital display resolution is 10 RPM.

Engine Hours: When the engine is off, the digital display shows the total accumulated engine hours to a maximum of 5999.9 hours. Engine hours are accumulated any time RPM is greater than 1500.

A warning alert activates when the RPM redline is reached. The VM 1000 display will flash, if installed, the EC100 displays the warning and an audible tone is heard.

Doc # DA202-C1 Revision 8	December 7, 1999	Page S6 - 4 DOT Approved
------------------------------	------------------	-----------------------------

### 7.3. Manifold Pressure

The manifold pressure system provides an analog display and a three place digital display. The full sweep analog display resolution is 1" Hg. The digital display resolution is 0.1" Hg.

A warning alert activates when the manifold pressure redline is reached. The VM 1000 display will flash, if installed, the EC100 displays the warning and an audible tone is heard.

### 7.4. Oil System

Oil temperature and oil pressure are displayed continuously on an analog and a digital display.

**Oil Pressure:** As oil pressure rises, the analog display increases proportionately. The digital display reads in increments of 1 PSI. A warning alert activates whenever the oil pressure redline is reached. The VM 1000 display will flash, if installed, the EC100 displays the warning and an audible tone is heard.

**Oil Temperature:** As oil temperature rises, the analog display increases proportionately. The digital display reads in increments of 1 degree Fahrenheit to a maximum of 300 degrees. A warning alert activates whenever the oil temperature rises above the redline. The VM 1000 display will flash, if installed, the EC100 displays the warning and an audible tone is heard.

### 7.5. Fuel Pressure

**Fuel Pressure:** As fuel pressure rises, the analog display increases proportionately. The digital display reads in increments of 1 PSI. A warning alert activates whenever the fuel pressure redline is reached. The VM 1000 display will flash, if installed, the EC100 displays the warning and an audible tone is heard.

### 7.6. Fuel Computer System

The fuel computer portion of the VM 1000 is not operational on the DA20-C1

### 7.7. Electrical System

Voltage is displayed both analog and digitally. Full color range marks provide a quick reference for fast analysis of voltage levels. As voltage rises, the analog display increases proportionally. The digital readout is at 0.1 volt resolution. A warning alert activates whenever the voltage redline is reached. The VM 1000 display will flash, if installed, the EC100 displays the warning and an audible tone is heard.

Amperage is displayed both analog and digitally. The load being monitored is the electrical current the generator is supplying to the system. When the electrical load is increased by turning on equipment, the ammeter will show an increase. When the load being supplied by the generator drops below approximately 2 amps the VM 1000 display will flash, if installed, the EC100 displays the warning and an audible tone is heard.

Doc # DA202-C1 Revision 8	December 7, 1999	Page S6 - 5 DOT Approved
------------------------------	------------------	-----------------------------

### 7.8. Fuel Quantity

Fuel quantity is displayed on a separate indicator but is controlled by the VM 1000 Data Processing Unit and EC 100 remote display. Display resolution is 1 US gallon. When 5 US gallons remain in the main tank the fuel system display is flashed an audible tone is heard and the EC 100 displays the warning.

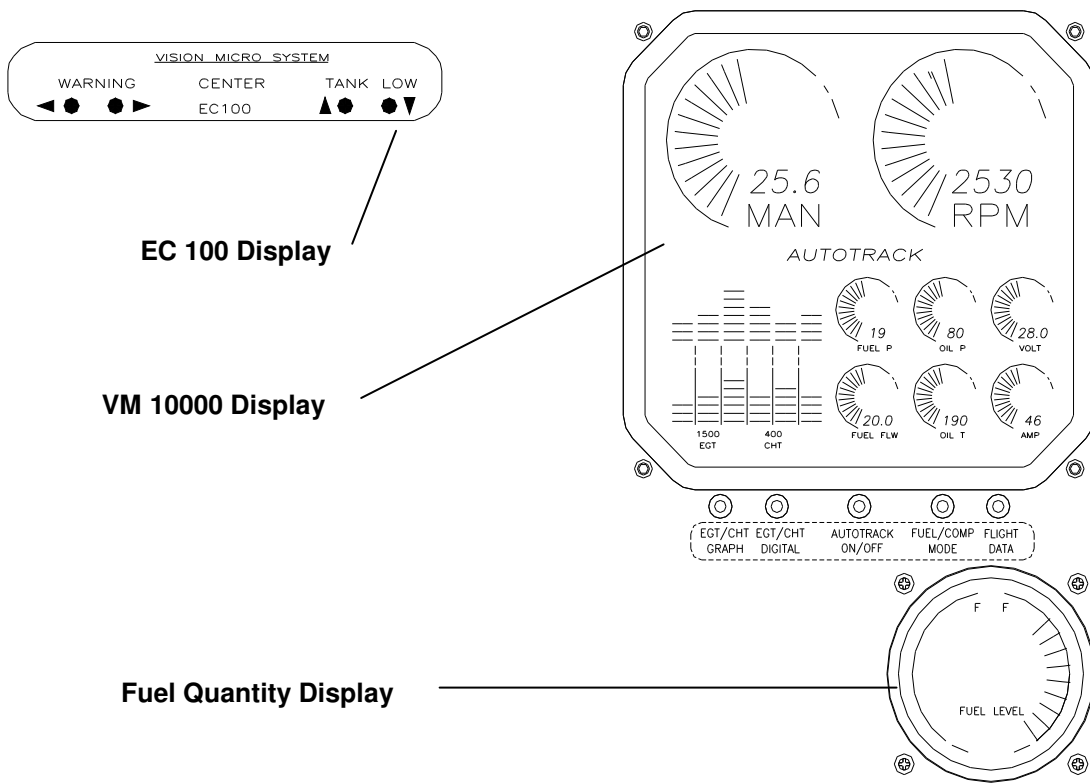

Figure 1



## 8. HANDLING, PREVENTATIVE AND CORRECTIVE MAINTENANCE

Service and maintenance of the VM 1000 / EC 100 system shall be performed according to the Diamond Aircraft Maintenance Manual (Document number DA201-C1).

Doc # DA202-C1 Revision 8	December 7, 1999	Page S6 - 7 DOT Approved
------------------------------	------------------	-----------------------------

## CHAPTER 9

## SUPPLEMENT 7

**Auxiliary Fuel System**

1. GENERAL	S7- 2
2. OPERATING LIMITATIONS	S7- 2
3. EMERGENCY PROCEDURES	S7- 2
4. NORMAL PROCEDURES	S7- 2
5. PERFORMANCE	S7- 4
6. WEIGHT AND BALANCE	S7- 4
7. DESCRIPTION OF THE AIRPLANE AND ITS SYSTEMS	S7- 4
8. HANDLING, PREVENTATIVE AND CORRECTIVE MAINTENANCE	S7- 6

## 1. GENERAL

This supplement addresses the optional installation of an auxiliary fuel tank system (Mod No 60). The optional auxiliary fuel system installation provides extended range operation by increasing the total fuel capacity of the DA20-C1 by 5 US gallons.

Only portions of the flight manual affected by the installation are included in this supplement.

## 2. OPERATING LIMITATIONS

### NOTE

Refer to all of the Operating Limitations with the following inserted into the appropriate place.

1. Initiate fuel transfer only when main tank is less than  $\frac{3}{4}$  full.

### 2.4. Placards

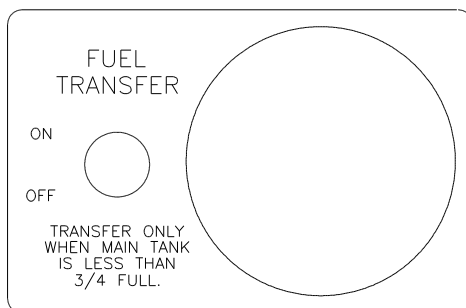

1. On the lower right corner of the instrument panel

Fuel Drains Located Underneath.  
Ground Aircraft before Refueling. ↓

2. Above the auxiliary fuel filler cap on the R/H side of the fuselage.

USEABLE 19L/5.1 US gal.  
AVGAS 100LL

3. Above the auxiliary fuel filler cap on the R/H side of the fuselage.

AUXILIARY TANK  
USEABLE  
19L/5.1 US gal.

4. On the face of the auxiliary fuel tank gauge.

FUEL DRAINS

5. On the underside of the fuselage, to the right, just forward of the wing trailing edge.

## 3. EMERGENCY PROCEDURES

Emergency procedures are not affected by the Auxiliary Fuel Tank system.

## 4. NORMAL PROCEDURES

### NOTE

Refer to all of the Normal Operating Procedures with the following inserted into the appropriate places.

Doc # DA202-C1 Revision 8	December 7, 1999	Page S7 - 2 DOT Approved
------------------------------	------------------	-----------------------------

**CAUTION**

The aircraft must be grounded prior to and during fueling. Use the ground stud, located under the trailing edge of the left wing.

**NOTE**

It is recommended to fill the main tank first and to full capacity before filling the auxiliary tank.

When using the auxiliary fuel tank, it is recommended to fill the tank to full capacity.

**4.4. NORMAL OPERATION CHECKLIST**

**4.4.1. Preflight Inspection**

**I. In-Cabin Check**

Insert after item 9.:

9a. Fuel Transfer check OFF

**II. Walk Around Check and Visual Inspection**

Insert after item 3. f):

If using auxiliary tank:

g) Auxiliary Fuel Tank Vent check clear

h) Auxiliary Fuel Tank Drain drain water

i) Auxiliary Fuel Tank Quantity check Full

**4.4.2. Before Starting Engine**

Insert after item 11.:

11b. Fuel transfer check OFF

**4.4.6. Before Take-off (Engine Run-up)**

Insert after item 7.:

7b. Auxiliary Fuel Tank Indicator check

**4.4.18. Auxiliary Tank Fuel Transfer**

**NOTE**

It is recommended to transfer fuel in level cruise flight.

1. Main fuel tank. less than ¾ full

2.	Auxiliary fuel tank indicator	Full
3.	Fuel Transfer switch	ON
4.	Transfer time	10 minutes
5.	Auxiliary fuel tank indicator	Empty
6.	Main fuel tank	1/5 capacity increase
7.	Fuel Transfer switch	OFF

**5. PERFORMANCE**

There is no change in airplane performance with the Auxiliary Fuel Tank system installed.

**6. WEIGHT AND BALANCE**

The installation (including unusable fuel) adds 10.6 lbs ( 4.8 kg) of weight at 32.4 in (0.823 m) moment arm.

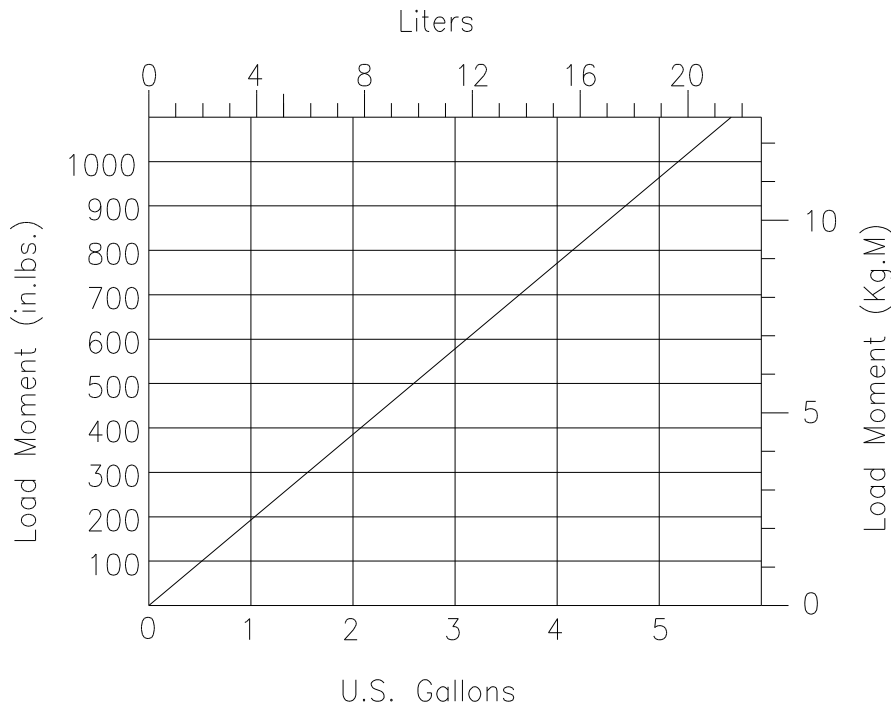
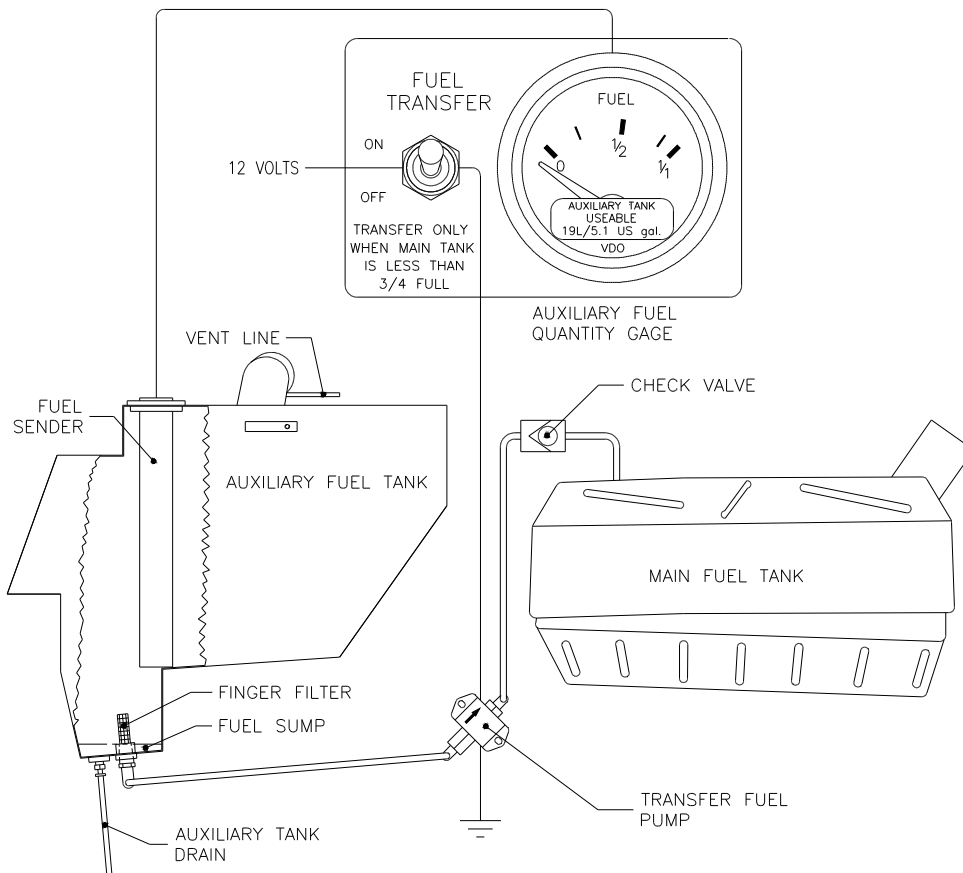

**Figure 1**  
Auxiliary Fuel Moment Chart

## 7. DESCRIPTION OF THE AIRPLANE AND ITS SYSTEMS

The auxiliary fuel tank is located in the fuselage, aft of the passenger compartment and underneath the baggage compartment floor, on the right hand side of the main fuel tank.

Fuel is gravity fed from the auxiliary tank to the electric transfer pump, which is used to pump fuel from the auxiliary fuel tank to the main fuel tank. From the pump, fuel flows through a check valve and into the top of the main fuel tank. The check valve is installed between the auxiliary tank and the main tank to prevent siphoning of fuel from the main tank back into the auxiliary tank. The only ports in the auxiliary fuel system are the auxiliary tank outlet and drain. All auxiliary fuel system components are grounded to each other and the external ground stud, located under the trailing edge of the left wing.



**Figure 2**  
**Fuel System Schematic**

---

## 8. HANDLING, PREVENTATIVE AND CORRECTIVE MAINTENANCE

Service and maintenance of the Auxiliary Fuel Tank system shall be performed according to the Diamond Aircraft Maintenance Manual (Document number DA201-C1).

Doc # DA202-C1 Revision 8	December 7, 1999	Page S7 - 6 DOT Approved
------------------------------	------------------	-----------------------------

## CHAPTER 9

## SUPPLEMENT 8

**Stick Mounted Trim Switches**

1. GENERAL	S8- 2
2. OPERATING LIMITATIONS	S8- 2
3. EMERGENCY PROCEDURES	S8- 2
4. NORMAL PROCEDURES	S8- 2
5. PERFORMANCE	S8- 2
6. WEIGHT AND BALANCE	S8- 2
7. DESCRIPTION OF THE AIRPLANE AND ITS SYSTEMS	S8- 2
8. HANDLING, PREVENTATIVE AND CORRECTIVE MAINTENANCE	S8- 3



## 1. GENERAL

This supplement addresses the optional installation of a stick mounted trim switch system. Only portions of the flight manual affected by the installation are included in this supplement.

## 2. OPERATING LIMITATIONS

There is no change in to the operating limitations with the stick mounted trim switch installed.

## 3. EMERGENCY PROCEDURES

There is no change in to the emergency procedures with the stick mounted trim switch installed.

## 4. NORMAL PROCEDURES

There is no change in to the normal procedures with the stick mounted trim switch installed.

## 5. PERFORMANCE

There is no change in airplane performance with the trim switch installed.

## 6. WEIGHT AND BALANCE

The change in weight and balance is negligible with the installation of the stick mounted trim switches.

## 7. DESCRIPTION OF THE AIRPLANE AND ITS SYSTEMS

Trim Switches are located on top of each Control Stick, aft of centre. The switches are positioned so that they can be easily operated by thumb. Forward movement of either switch gives nose down trimming and aft movement of the switch gives nose up trim. The trim switches control electrical relays that supply electrical power to the electric pitch trim motor. If the switches are operated in opposing directions at the same time the trim motor will not operate. Operation of the trim switches in the same direction and at the same time will cause the trim motor to operate in that direction.

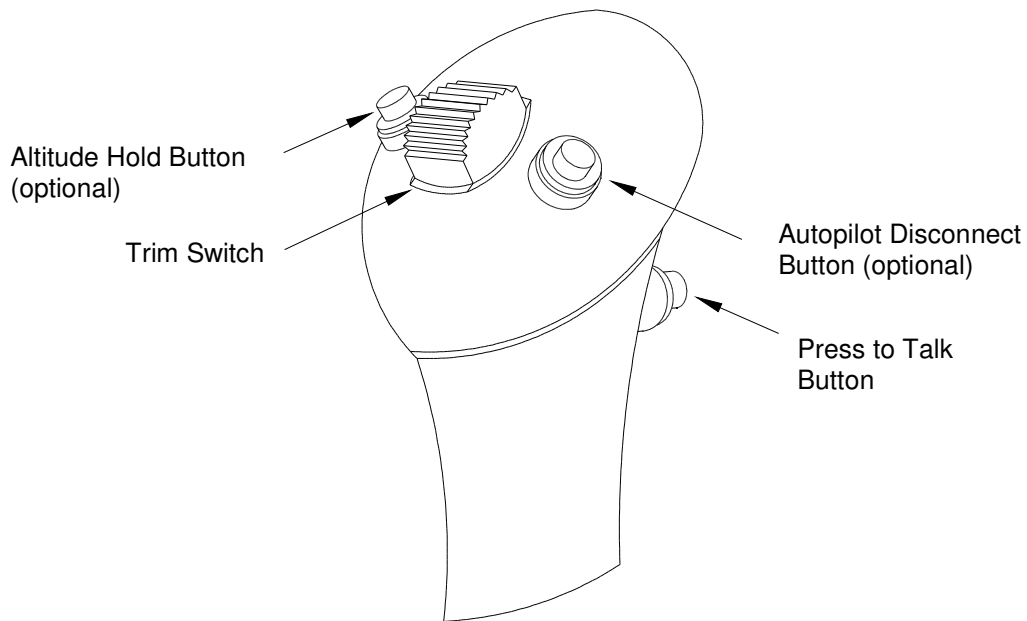

Control Stick Grip (Left-hand Shown)  
Figure 1

## 8. HANDLING, PREVENTATIVE AND CORRECTIVE MAINTENANCE

Service and maintenance of the Stick Mounted Trim Switches shall be performed according to the Diamond Aircraft Maintenance Manual (Document number DA201-C1).

CHAPTER 9  
SUPPLEMENT 9  
**20 US Gallon Fuel Tank**

1. GENERAL	S9- 2
2. OPERATING LIMITATIONS	S9- 2
3. EMERGENCY PROCEDURES	S9- 2
4. NORMAL PROCEDURES	S9- 2
5. PERFORMANCE	S9- 2
6. WEIGHT AND BALANCE	S9- 2
7. DESCRIPTION OF THE AIRPLANE AND ITS SYSTEMS	S9- 2
8. HANDLING, PREVENTATIVE AND CORRECTIVE MAINTENANCE	S9- 3

## 1. GENERAL

This supplement addresses the optional installation of a smaller 20.5 US gallon fuel tank in place of the standard 24.5 US gallon fuel tank. Only portions of the flight manual affected by the installation are included in this supplement.

## 2. OPERATING LIMITATIONS

### 2.14 Fuel

Fuel Capacity:

Total Fuel Quantity	:20.5 US gal. (78.0 liters)
Usable Fuel	:20.0 US gal. (76.0 liters)
Unusable Fuel	:0.5 US gal. (2.0 liters)

### 2.15 Placards

6. On the fuel quantity indicator:

Usable  
76L/20 US gal.

19. Next to the fuel filler cap:

78L/20.5 US gal. AVGAS 100LL  
USABLE 76L/20 US gal.

## 3. EMERGENCY PROCEDURES

There is no change in to the emergency procedures.

## 4. NORMAL PROCEDURES

There is no change in to the normal procedures.

## 5. PERFORMANCE

The range with 30 minute reserve fuel is reduced by approximately 19% with the 20.5 US gallon fuel tank installed in place of the 24.5 US gallon tank.

## 6. WEIGHT AND BALANCE

Lever arm of fuel in the 20.5 US gallon tank: 30.08 in (0.764 m)

## 7. DESCRIPTION OF THE AIRPLANE AND ITS SYSTEMS

### 7.10 Fuel System

A 20.5 US Gal total / 20.5 US Gal usable fuel tank replaces the standard 24.5 US Gal total / 24.0 US Gal usable fuel tank. There are no other changes to the fuel system.

**7.10.5 Fuel Dipstick**

A fuel dipstick P/N 22-2550-18-00, is supplied with all aircraft with the 20 US gallon fuel tank installed. This dipstick permits direct measurement of the fuel level during the pre-flight check.

**8. HANDLING, PREVENTATIVE AND CORRECTIVE MAINTENANCE**

There is no change in handling, preventative or corrective maintenance with the 20 US gallon fuel tank installed.

## CHAPTER 9

## SUPPLEMENT 10

**Reversed Instrument Panel**

1. GENERAL	S10- 2
2. OPERATING LIMITATIONS	S10- 2
3. EMERGENCY PROCEDURES	S10- 2
4. NORMAL PROCEDURES	S10- 2
5. PERFORMANCE	S10- 2
6. WEIGHT AND BALANCE	S10- 2
7. DESCRIPTION OF THE AIRPLANE AND ITS SYSTEMS	S10- 3
8. HANDLING, PREVENTATIVE AND CORRECTIVE MAINTENANCE	S10- 3

## 1. GENERAL

This supplement addresses the optional installation of the navigation and powerplant instruments in a reversed configuration. The navigational instruments are located on the right hand side of the instrument panel. The powerplant instruments are located on the left hand side of the panel. Only portions of the flight manual affected by this installation are included in this supplement.

## 2. OPERATING LIMITATIONS

There is no change in the operating limitations.

## 3. EMERGENCY PROCEDURES

There is no change in to the emergency procedures.

## 4. NORMAL PROCEDURES

There is no change in to the normal procedures.

## 5. PERFORMANCE

There is no change in the performance of the aircraft.

## 6. WEIGHT AND BALANCE

The weight and balance of the aircraft is not affected.

Doc # DA202-C1 Revision 11	January 16, 2001	Page S10 - 2 DOT Approved
-------------------------------	------------------	------------------------------

## 7. DESCRIPTION OF THE AIRPLANE AND ITS SYSTEMS

### 7.4 Instrument Panel

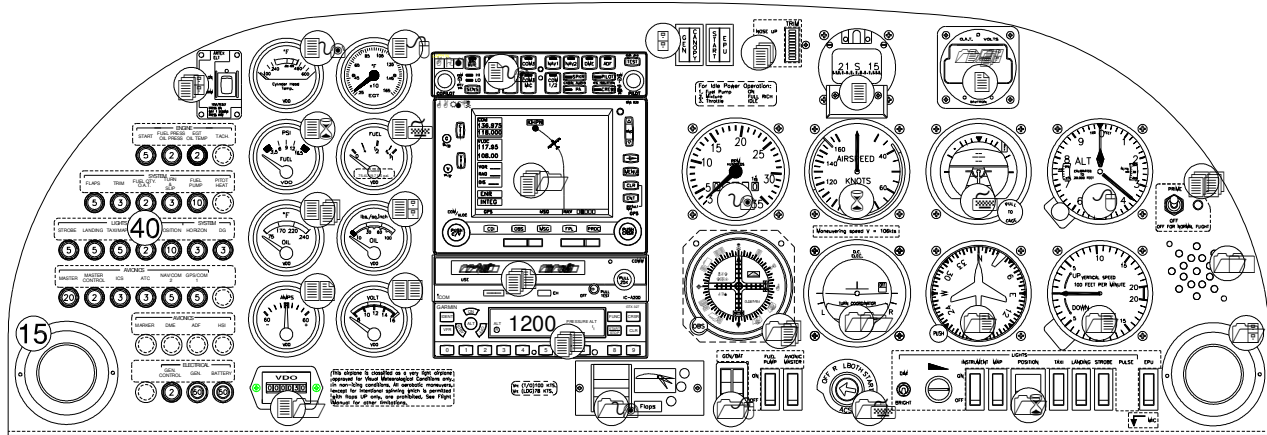

	Description		Description		Description		Description
1.	--	13.	Vertical Speed Ind.	25.	--	37.	Fuel Quantity Ind.
2.	Clock/OAT	14.	CDI	26.	--	38.	EGT Indicator
3.	Magnetic Compass	15.	Air Vent	27.	--	39.	CHT Indicator
4.	Trim Position Display	16.	Switch Panel	28.	--	40.	Circuit Breakers
5.	Annunciator Lights	17.	Ignition/Start Sw.	29.	Marker/Audio Panel	41.	Nav/Comm/GPS
6.	Airspeed Indicator	18.	Master Sw. Panel	30.	--	42.	Comm
7.	Artificial Horizon Ind,	19.	Flap Control	31.	Hour Meter	43.	Transponder
8.	Altimeter	20.	--	32.	Ammeter	44.	Fuel Prime Switch
9.	Tachometer	21.	--	33.	Voltmeter	45.	ELT Remote Switch
10.	Stall Warning Horn	22.	--	34.	Oil Temp. Ind.		--
11.	Turn Coordinator	23.	--	35.	Oil Pressure Ind.		--
12.	Directional Gyro	24.	--	36.	Fuel Pressure Ind.		--

## 8. HANDLING, PREVENTATIVE AND CORRECTIVE MAINTENANCE

There is no change in handling, preventative or corrective maintenance with this instrument panel configuration.



CHAPTER 9  
SUPPLEMENT 11  
**Pitot Heat Operation**

1. GENERAL	2
2. OPERATING LIMITATIONS	2
3. EMERGENCY PROCEDURES	3
4. NORMAL PROCEDURES	3
5. PERFORMANCE	4
6. WEIGHT AND BALANCE	5
7. DESCRIPTION OF THE AIRPLANE AND ITS SYSTEMS	5
8. HANDLING, PREVENTATIVE AND CORRECTIVE MAINTENANCE	5

# 1. GENERAL

Ice build up on the Pitot Static Probe can cause the airspeed, altimeter and vertical speed indicators to display incorrect data. The 'Pitot Heat' system provides protection against ice build up on the Pitot Static Probe.

Due to the increased electrical load when the 'Pitot Heat' system is operating, the ammeter must be monitored. When engine power settings are below cruise power and/or combinations of electrical system users result in a higher than normal power consumption, it may be necessary to manage the electrical load by, turning off unnecessary electrical consumers.

**CAUTION**

Checking operation by touching the probe after momentary application of power is not sufficient in determining proper system operation. The green Pitot current monitor light must illuminate during the test to confirm proper heating.

# 2. OPERATING LIMITATIONS

**2.15 PLACARDS** On the lower left side of the instrument panel above the switches.

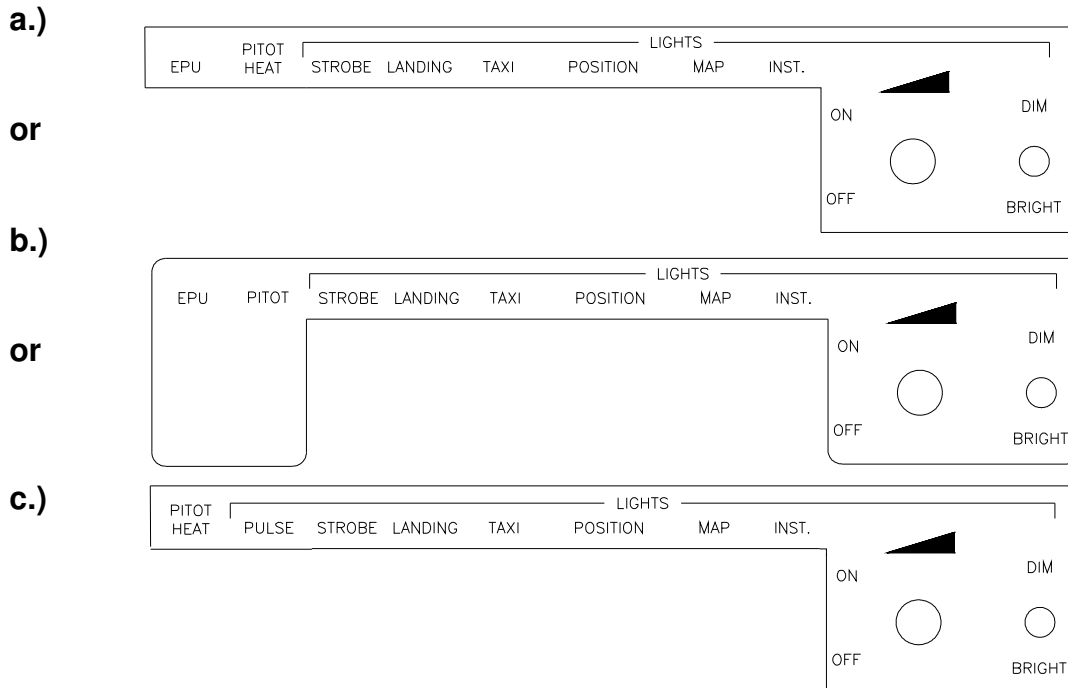

### 3. EMERGENCY PROCEDURES

**Icing:** Unintentional Flight into Icing Area Checklist has been repeated in this section to include operations with pitot heat system installed.

#### 3.3.5. Icing

##### Unintentional Flight into Icing Area

- |    |  |               |
|----|--|---------------|
| 1. | Pitot Heat   | ON            |
| 2. | Leave icing area (through change of altitude or change of flight direction to reach area with higher outside air temp.). |               |
| 3. | Continue to move control surfaces to maintain their moveability  |               |
| 4. | Alternate Air  | ON            |
| 5. | Increase RPM to avoid icing of propeller blades (observe maximum RPM)  |               |
| 6. | Cabin Heat   | ON<br>DEFROST |

**CAUTION**

In case of icing on the leading edge of the wing, the stall speed will increase.

**CAUTION**

In case of icing on wing leading edge, erroneous indicating stall warning should be expected.

### 4. NORMAL PROCEDURES

#### 4.4.0 General

The 'Pitot Heat' system should be operated where meteorological conditions warrant its use and where government regulations require its operation.

As part of **4.4.1. Preflight Inspection** Walk Around, check the pitot probe insulating spacer for signs of charring near the pitot probe. If signs of overheating are present maintenance action will be required prior to flight.

#### 4.4.4 NORMAL OPERATION CHECKLIST

**Before Taxiing:** The Before Taxiing Checklist has been repeated in this section to include operations with 'Pitot Heat' system installed.

##### 4.4.4 Before Taxiing

- |     |  |  |
|-----|--|--|
| 1.  | Avionics Master Switch                                 | ON   |
| 2.  | Flight Instruments and Avionics                        | set  |
| 3.  | Engine Gauges  | check  |
| 4.  | Voltmeter  | check, ensure needle is in the green arc.<br>Increase RPM to achieve or turn OFF non-flight essential electrical consumers |
| 5.  | Warning Lights, Gen, Canopy, Start, EPU (if installed) | push to test   |
| 6.  | Fuel Prime   | Check OFF  |
| 7.  | Fuel Pump  | Check ON   |
| 8.  | Pitot Heat Switch                                      | ON   |
| 9.  | Pitot Heat Monitor Light                               | ON, operational and dimmable   |
| 10. | Pitot Heat Switch                                      | OFF  |
| 11. | Parking Brake  | release  |

### NOTE

The ground test of the pitot heat should be kept to the minimum length of time required to verify normal operation (max. 10 seconds). Operation of the pitot heat system on the ground is unnecessary and will shorten the life of the heaters.

### CAUTION

Warm-up engine to a minimum Oil Temperature of 75° F at 1000 to 1200 RPM (also possible during taxi). Do not operate engine above 1000 RPM until an oil temperature indication is registered.

## 5. PERFORMANCE

There is no change in airplane performance associated with pitot heat operation.

## 6. WEIGHT AND BALANCE

The weight and balance of the aircraft is not affected by operation.

## 7. DESCRIPTION OF THE AIRPLANE AND ITS SYSTEMS

### 7.12.1 Pitot Heat

The 'Pitot Heat' system consists of heating elements imbedded in the Pitot Static Probe, a 15 amp circuit breaker, a control relay, thermal limit switches (HIGH and LOW), OFF/ON switch, and a GREEN LED monitor. The control relay closes and supplies electrical current to the Pitot Static Probe heaters when the PITOT SWITCH is set to ON and the LOW thermal limit switch is CLOSED. A current monitoring sensor confirms this by activating the GREEN LED monitor light. The LOW thermal limit switch with automatic reset will cycle the control relay if the system is ON and an overheat condition exists. If the LOW temperature limit switch activates it will inhibit Pitot Static Probe heater operation and the GREEN LED monitor will go OFF until the Pitot Static Probe temperature drops below approximately 50 degrees Celsius.

## 8. HANDLING, PREVENTATIVE AND CORRECTIVE MAINTENANCE

To prevent premature failure of the heating elements the ground test of the pitot heat should be kept to the minimum length of time required to verify normal operation (max. 10 seconds).

Operation of the pitot heat system on the ground is unnecessary and will shorten the life of the heaters.

Doc # DA202-C1 Revision 14	August 9, 2001	Page S11 - 5 DOT Approved
-------------------------------	----------------	------------------------------